

SENTRY® 300 S / 300 D

High Quality Low Voltage Vehicular Swing Gate Opener

Battery Powered Solar or AC Charged

Installation/Owners Manual

*Designed to
open all types
of gates in all
kinds of places.*

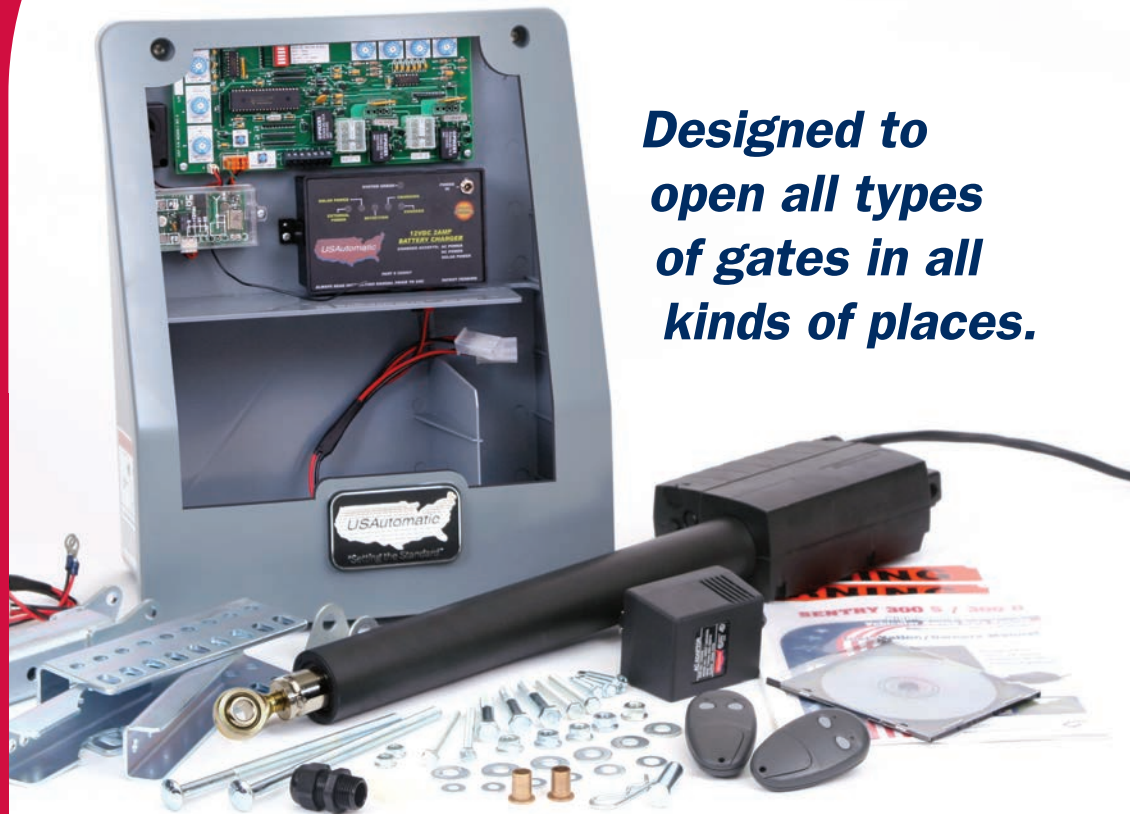

3
Year
Warranty



Distributed by: QuickGateOpeners.com

MADE IN THE USA

www.sentrygateopener.com



TABLE OF CONTENTS

INTRODUCTION

About the Sentry.....	2
Safety Information	3
Sentry Parts Inventory.....	5
Sentry Hardware Inventory.....	6
General Tool Requirements.....	6

PREPARATION AND OVERVIEW

Gate Qualifications/Applications.....	7
Proper Gate Design.....	7

INSTALLATION

1. Mounting Site Review	8
2. Determine Proper Brackets and Opening Method.....	9
3. Attaching Universal Actuator Bracket to Hinge Post or Post Being Used	11
4. Attach Actuator Bracket to Universal Actuator Bracket	12
5. Install Linear Actuator to Actuator Bracket	12
6. Install Gate Bracket to Linear Actuator	13
7. Install Gate Bracket to Gate.....	13
8. Prepare Control Box for Installation.....	13
9. Install Sentry Control Box	14
Splicing for Sentry 300 S Linear Actuator Cable (if needed)	
10. Sentry Plug N Go Harness	15
11. Install Battery	15
12. Install Charging System (AC or Solar).....	16
13. Connect Charge Device to Charge Controller	17
14. Charge Controller Operation Check	17
15. Install Linear Actuator Cable.....	18
16. Sentry Plug N Go Harness Final Installation	18
17. Sensitivity Adjustments and Entrapment Alarm	19
19. Adjusting Gate 1 and Gate 2 Sensitivity	20
20. Extend and Retract Limit Adjustments.....	20
21. Operating Gate for the First Time	21
22. Making Final Adjustments.....	21
23. Install Safety Signs	22
24. Programming Transmitter and Receiver.....	22

ENTRAPMENT ZONES..... 24

PERIODIC SERVICE..... 24

SENTRY 300 D GATE 2 INSTALLATION..... 25

ACCESSORIES..... 28

TROUBLESHOOTING..... 34

APPENDIX..... 41

WARRANTY..... 45

SENTRY® 300 Series AUTOMATIC GATE OPENER



The Sentry Gate Opener is intended to be installed on vehicular Class I, II, III or IV gates as defined by UL 325, (the standard that regulates gate opener safety, as established and made effective March 14, 2003, by Underwriters Laboratories, Inc.)

The Sentry Gate Opener is the first truly solar charged gate opener for the Do It Yourself market. The system design and the accessories recommended are all Solar Friendly meaning that they require the least amount of energy possible to perform the job they were designed to do. The solar option allows you to install the gate opener in remote areas or in applications where you prefer to be solar charged. Solar charging provides isolation from lightning that might damage the unit via the AC power needed for the transformer.

The Sentry Gate Opener is powered by a 12 VDC battery (not included). This battery is charged by the supplied transformer which requires AC power (120 VAC) to be either at the gate area or within 1000 feet of the gate area. If the AC power is more than 10 feet from the gate opener control box then additional extension cable is required (see Sentry charge cable extension kit information). If preferred, you may use the optional Sentry Solar Panel kit (PN 520015) to charge the battery. Typically only one panel will be required. The Sentry Gate Opener is capable of a high number of cycles per day. For information on what you can expect from a solar charged system see the solar charging section of this manual. (page 41) Accessories that are added to your gate opener must be solar friendly accessories and they will be identified as such.

The Sentry Gate Opener features an easy to connect Plug N Go wiring harness that eliminates the need for any complicated wiring. The only wiring required consists of two wires from the harness that must be connected to the battery positive terminal (red wire) and battery negative terminal (black wire). All components have been pre-installed so that installation can typically be completed in less than one hour.

The Sentry control board features high quality components and industry leading ideas such as auto resetting fuses for motor protection. The old automotive type fuse that frequently fail have been designed out of this controller to avoid the unnecessary expense of buying fuses. Another patent pending item designed into the control board is the on board potentiometers for adjusting stop limits. Many other features have been designed into the control board to ensure superior operation for years to come. Attention to detail and quality parts makes the Sentry Gate Opener the First High Quality Gate Opener for the Do It Yourself Installer. USAutomatic appreciates the fact you have recognized the quality of the Sentry gate opener for your installation and would appreciate your comments on how we are doing so that we may continue to build and design products in the future that work the way you want them to.

PLEASE READ THE ENTIRE MANUAL CAREFULLY PRIOR TO INSTALLATION.

In doing so, along with performing the installation in step-by-step order, you will achieve optimal results. Your Sentry control board was designed with a current sense safety feature and we strongly recommend other safety devices such as photo eyes to make each particular installation as safe as possible and reduce the risk of personal injury and/or property damage. Please read carefully and understand the Safety Section of the manual.

SAFETY INSTALLATION INFORMATION

USAutomatic gate operators are certified to UL325 Vehicular Class I, II, III and IV swing gate standards. UL325 identifies four different classes of gate operators. These classes are:

Class I : Residential vehicular gate operator- vehicular gate operator (or system) intended for use in a home of one to four single family dwellings or a garage or parking area associated therewith.

Class II : Commercial/General access vehicular gate operator- vehicular gate operator (or system) intended for use in a commercial location or building such as multi-family housing unit (five or more single family units), hotel garages, retail, or other buildings servicing the general public.

Class III : Industrial/Limited access vehicular gate operator- vehicular gate operator (or system) intended for use in an industrial location or building such as a factory or loading dock area or other locations not intended to serve the general public.

Class IV : Restricted Access vehicular gate operator- vehicular gate operator (or system) intended for use in a guarded industrial location or building such as an airport security area or other restricted access locations not servicing the general public, in which unauthorized access is prevented via supervision by security personnel.

INSTALLATION

Install the gate operator when:

- Operator is appropriate for the construction of the gate and usage class is correct for the installation.
- All exposed pinch points are eliminated or guarded.
- The gate is a vehicle gate. Pedestrians must be supplied with a separate access opening.
- The gate is installed in a location where enough space is supplied between adjacent structures and the gate that when opening or closing the chance of entrapment is reduced.
- The gate does not swing into public access areas.
- The gate is properly installed and swings freely in both directions. Do not over adjust the sensitivity adjustment to compensate for an improper gate installation.
- All controls are located at least six feet away from the gate to eliminate the chance of the person operating the gate from coming in contact with the moving gate. Do not install external buttons, which can be used to operate the gate within the reach of children.
- Placards are installed, one on each side of the gate and visible in the gate area.
- All contact sensors used for secondary entrapment safety devices and their wiring is installed in a manner which protects them from mechanical damage.
- All non-Contact sensors used for secondary entrapment safety devices are located so that the signal from the transmitter to the receiver is not interfered with by adjacent structures. All exposed wiring must also be protected from mechanical damage.

SECONDARY ENTRAPMENT DEVICES

USAutomatic designs all control boards with secondary entrapment inputs. USAutomatic recommends that UL325 listed secondary safety devices be installed with all installations. USAutomatic recommends that these devices be connected after proper gate installation and operation has been verified. Then connect one device at a time to verify proper operation before installing the next device. Ensure that power is disconnected from the control board prior to wiring any accessory.

WARNING

TO REDUCE THE RISK OF INJURY OR DEATH

1. **READ AND FOLLOW ALL INSTRUCTIONS**
2. Study the entire Safety Section paying particularly close attention to the entrapment zones and be aware of these areas not only during use but also during any adjustments to the unit.
3. Do not attempt to enter the gate area while the gate is moving. Wait until the gate comes to a complete stop.
4. Never let children operate or play with gate controls or any other activation device. Keep remote control away from children.
5. **DO NOT ALLOW CHILDREN TO PLAY IN THE AREA OF THE GATE.**
6. Do not allow anyone to ride on the gate.
7. Always keep people and objects away from the gate.
8. **NO ONE SHOULD CROSS THE PATH OF A MOVING GATE.**
9. Operate the gate only when it is fully visible, free of persons or obstructions, and properly adjusted.
10. Do not attempt to “beat the gate” while the gate is opening or closing. This is extremely dangerous.
11. Test gate operator monthly. The gate must stop and reverse directions upon contacting a rigid object or when the secondary entrapment device is activated.
12. After all adjustments have been made to the sensitivity (current sense) circuit, secondary entrapment devices and all other external devices installed, the safety devices must be checked again. Failure to adjust and retest the gate operator can increase the risk of injury or death.
13. Verify that the emergency release (manual release) pin can be easily removed.
14. **KEEP GATES PROPERLY MAINTAINED.** Tighten all bolts and grease hinges and pivot points.
15. **THE ENTRANCE IS TO BE USED BY VEHICLES ONLY.** Pedestrians must use a separate entrance.
16. All safety features required by UL 325 are incorporated in the capabilities of all USAutomatic Control boards and should be utilized, including but not limited to, safety edges, photo electric eyes, reverse sensing.
17. Test the current sense feature and all safety devices regularly to insure correct operation.
18. The USAutomatic battery charger is designed to operate with a recommended +12 VDC, sealed maintenance free type Group U-1 battery. 30 amp hour minimum.
19. All control stations should be located at least 6 feet from any moving part of the gate or operator.
20. Do not ever install any control device where a user will be tempted to reach through the gate or fence to activate a gate.
21. Do not attempt to completely seal the control box. Battery needs some air flow.
22. **SAVE THESE INSTRUCTIONS!!**

SENTRY 300 Series PARTS INVENTORY

part number 020320



Universal Actuator Bracket

Part # 610400
1 per



Square Post Flush Mount Bracket

Part # 610402
1 per



Round Post Flush Mount Bracket

Part # 610404
1 per



Actuator Bracket

Part # 610406
1 per



Gate Bracket

Part # 610105
1 per



Gate Support Bracket

Part # 610120
2 per



Bronze Bushing

Part # 610530
2 per



Manual release pin

Part # 610534
1 per



Manual release clip

Part # 610535
1 per

Linear Actuator

Part # 510300
1 per



Harness

Part # 630040
1 per



1/2" Cable Gland

Part # 620022
1 per



Entrapment Siren

Part # 530015
1 per



Safety Sign

Part # 601027
2 per



Instructional DVD

1 per



Transmitter

Part # 030210
2 per



Transformer

Part # 520008
1 per



Charge Controller

Part # 520007
1 per (Installed)



LCR Receiver

Part # 030200
1 per (Installed)

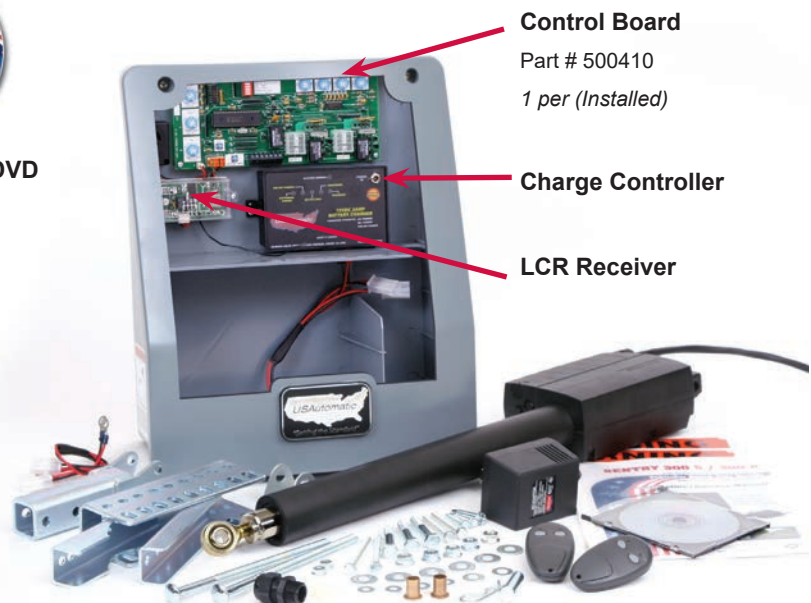

Control Board

Part # 500410
1 per (Installed)

Charge Controller

LCR Receiver

HARDWARE INVENTORY



3/8 x 16 nylon lock nut
Part # 610518
5 per



1/4 x 20 nylon lock nut
Part # 610526
2 per



3/8 USS flat washer
Part # 610514
6 per



3/8 SAE flat washer
Part # 610516
2 per



1/4 SAE flat washer
Part # 610524
4 per



Nylon washer
Part # 610528
2 per



3/8 x 2 1/2" shoulder bolt
Part # 610512
3 per



3/8 x 16 x 8" carriage bolt
Part # 610510
2 per



Tap bolt
1/4 x 20 x 3 1/2"
Part # 610522
2 per



Tap bolt
1/4 x 20 x 2 1/2"
Part # 610520
2 per



#12 x 1 1/4 self tap hex screw
Part # 610532
4 per

GENERAL TOOL REQUIREMENTS

Tools required for most installations:

- Wrenches – 7/16, 9/16 and 10mm
- Drill
- Drill adapter for socket attachment
- Hack saw
- Sockets 7/16, 3/8 and 5/16
- Drill bits 1/4 and 3/8 inch
- Pliers
- Level and tape measure

Welding is the recommended method of securing the linear actuator mounts to the gate and hinge post. Bolt on brackets are provided and are acceptable but may require frequent service to keep tight. They must be very securely attached (i.e. carriage bolts with lock nuts and washers). Lag type bolts are not recommended. Loose or unstable linear actuator mounts will result in improper operation.

IMPORTANT CAUTIONS:

1. Do not perform any welding with the actuator cable plugged into the control board or the battery connected. Serious damage to the control board and/or battery may occur if attempted.
2. Use control box as a template to determine mounting screw locations and then attach screws and slide on control box. Do not attempt to hold control box and drill mounting holes. This could damage the preinstalled components.
3. Always disconnect the battery power from the control board using the Plug N Go harness prior to wiring any devices to the control board.

GATE QUALIFICATIONS/APPLICATIONS

The Sentry gate opener is designed and rated for vehicular class I, II, III or IV swing gates up to 20 feet in length. Maximum gate load not to exceed 400 pounds and 20 feet in length.

The Sentry Gate Opener is recommended for Gates that meet the following descriptions:



Ornamental Iron

12 feet max length
Max weight 400 lbs.



Ranch Gate

14 feet max length
Max weight 400 lbs.



Farm Gate

20 feet max length
Max weight 300 lbs.



Chain Link Gate

16 feet max length
Max weight 350 lbs.

The Sentry gate opener is designed and supplied with universal mounting brackets to fit most types of gate installations. Hinge post from 2 3/8" to 6" round or square can be used with the included universal mounting hardware.

PROPER GATE DESIGN

IMPORTANT- A GATE OPENER CANNOT OVERCOME A POORLY DESIGNED GATE.

Since the gate is a major component of the system, great care and concern must be given to the gate design. USAutomatic, LTD is not responsible for any damage to a gate in which the gate opener is installed. A poorly installed or misadjusted gate could be damaged. It is the responsibility of the installer to verify proper gate installation prior to opener installation. As a general rule, a gate, which is to be automatically operated, must be stronger and smoother than one operated manually.

- Does the gate swing smoothly without binds or excessive resistance?
- Swing gates should swing level and plumb to prevent the opener from having to lift the gate open or closed.
- Swing gates should not require a wheel to support them. Wheels create drag, which will cause opener problems. A wheel is generally a sign of a weak hinge system or a weak gate frame.
- Is the gate frame of substantial strength without excessive weight?
- Will the frame withstand normal wind load conditions without sway or vibration?
- Will the gate close correctly without being hand-guided or lifted to close?
- Are the hinges suited for an automatic gate opener? We recommend bearing type hinges to reduce friction drag.
- Will a reinforcement brace be required to attach the linear actuator to the gate or does a suitable cross member exist in the gate design?

If any of these problems exist, they must be corrected to achieve a reliable automatic gate system.

I Mounting Site Review

Review the following items prior to installation and predetermine the solution to any problems which may exist:

- Does sufficient space exist for mounting and future servicing of the opener and control box?
- Which direction will the gate swing?
- Will the gate opener pull the gate open to the inside (Pull to Open)?
- Will the gate opener push the gate open to the outside (Push to Open)?
- Where will the universal actuator bracket and gate bracket be secured at the hinge post and to the gate?
- Where will the control box be mounted to support the weight of the battery and can it be located within 8 feet to prevent splicing of the actuator cable?
- How will you charge the battery? Will it be AC or Solar charged?
- How far away is the 110 VAC receptacles for the transformer? Transformer is supplied with 12 feet of cable, if extension is needed use Sentry Charge Cable Extension Kit (part #630050). See Appendix B (pg 42) for extension cable kit information and recommended wire size chart for extension distance needed.
- If solar charged, where will the solar panel be located so that optimum sunlight is received? Solar panel in most cases needs to face a south west direction. Solar panel comes with 15' of cable. If more is needed, use Sentry Charge Cable Extension Kit (part #630050).
- How will accessory control wiring, if any, be brought to the control box? Knock outs are provided in control box bottom for conduit.
- Have all safety concerns been addressed? (See Safety Section pg. 3-4)

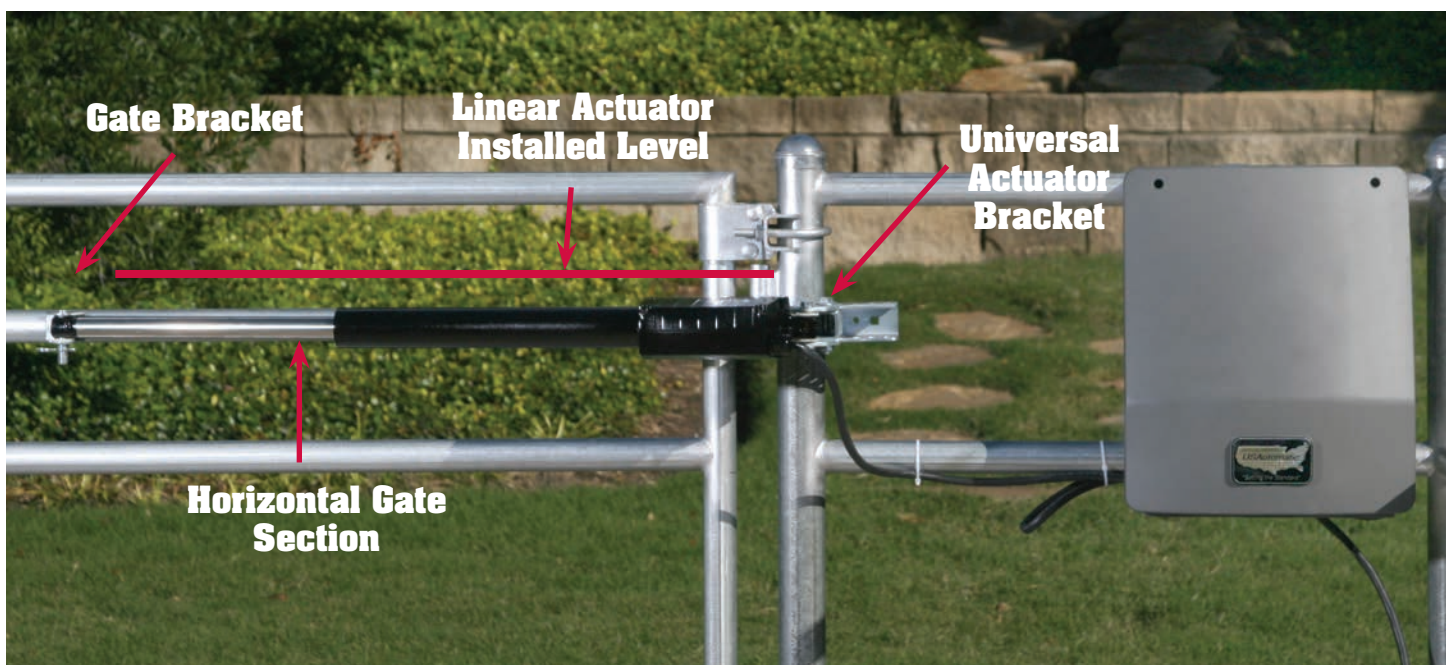

Sentry installed and shown in the extended position.
Actuator must be installed level and attached to a horizontal cross member as shown.

2 Determine Proper Brackets and Opening Method

Mounting Brackets

Determining which of the brackets will be needed for your installation.

The Sentry gate opener is supplied with universal brackets to mount on round or square hinge post ranging in size from 2 3/8" to 6". Some pieces may not be needed for your installation.

The hinge post is the post your gate hinges are attached to. Follow the steps below to identify which of the included brackets will be needed for your installation.

Is the hinge post round or square?

Square post will use the "square post flush mount bracket"

Round post will use the "round post flush mount bracket"

NOTE: If a round post is to be used it might be necessary to brace the post so that it does not rotate. A round post simply installed in concrete will rotate, if possible drill holes through the post and insert rebar through the post prior to concrete to prevent rotation.

Is the gate a light weight farm gate?

If so, use the "gate support brackets" to attach the gate bracket so that the bolts can be securely tightened.

Universal Actuator Bracket

The universal actuator bracket can be installed in many different ways to accommodate your gate opener installation. Use the images below to help understand the mounting options for this bracket and determine the installation method you are going to use. The images are for reference only and your installation might differ.

Universal actuator bracket must be securely installed. Drilling through the post is the strongest method. It is also recommended that the square post flush mount bracket or the round post flush mount bracket be installed for strength on opposite side of post from the universal bracket (see figures below).

When determining where the universal actuator bracket will mount on the hinge post you must also consider where the gate bracket is going to connect to the gate. The gate bracket is going to attach approximately 34" out on the gate measured from the gate hinge center.

Once universal actuator bracket location is determined, verify that the gate bracket can be installed to the gate so that linear actuator is level.

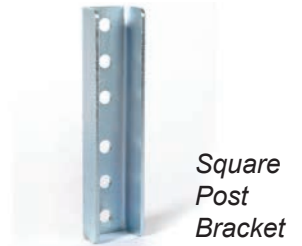

Square Post Bracket



Round Post Bracket



Universal Actuator Bracket

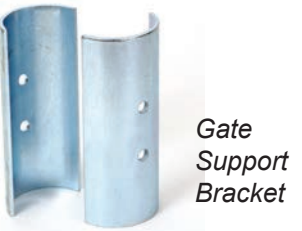

Gate Support Bracket

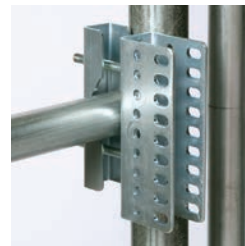

Pull to Open Installation

This installation method is the most common where the gate swings into the property/driveway.

No matter which way you decide to install the actuator bracket and universal actuator bracket the pivot point below must be located in approximately this position for a pull to open installation.

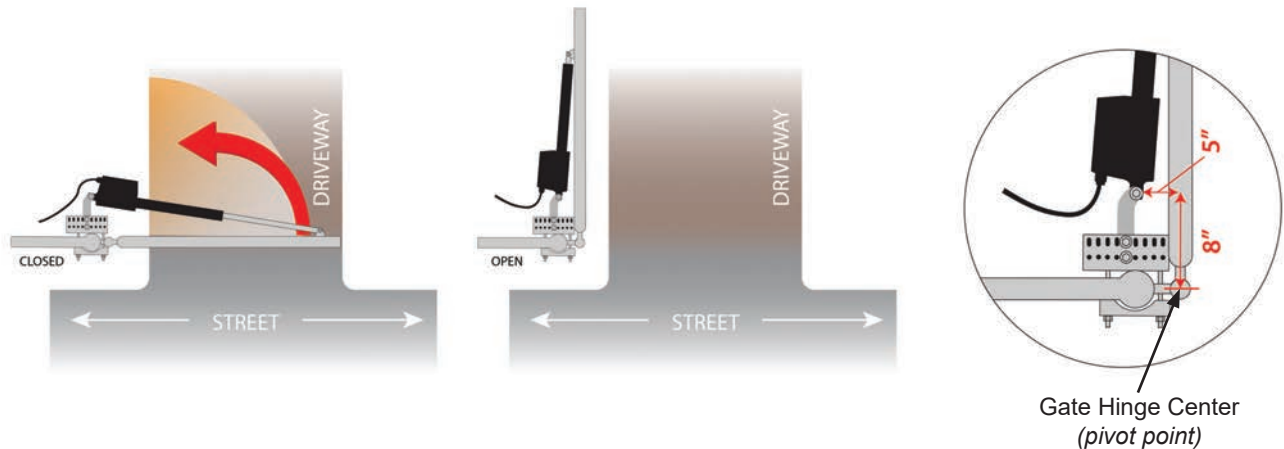

Push to Open Installation

This installation method is common where the driveway slopes up entering the property and gate must swing out to avoid interference. This type of installation places the actuator bracket and linear actuator into the drive area slightly. Another installation method would be to install as a Pull to Open and place linear actuator on outside of property.

Push to open installation can be achieved by installing universal actuator bracket and actuator bracket as shown in figure below. Dimensions for this install method are 7" and 4" from hinge center.

Universal actuator bracket hole pattern allows for the actuator bracket to be installed as shown in this location only. Establish enough offset in the rear actuator pivot point to allow the gate to close from the open position.

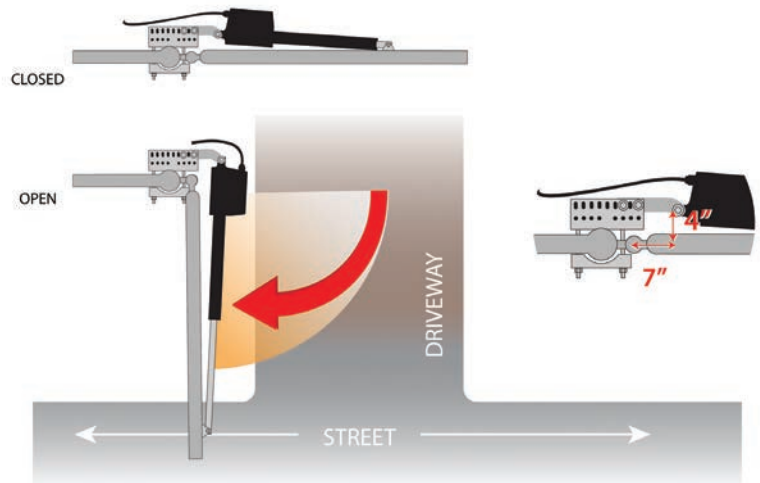

IMPORTANT: If Installation is Push to Open, control switch #2 "operating direction reverse" must be turned "ON".

NOTE: Pull to Open & Push to Open Dimensions are measured from the gate hinge center (pivot point).

3

Attach Universal Actuator Bracket to hinge post or post being used

Mounting hardware needed:

- two 3/8" x 16 x 8" carriage bolts
- two 3/8" USS flat washers
- two 3/8" nylon lock nuts

The universal actuator bracket can be installed in many different ways to accommodate your gate opener installation. The pictures here are for reference and your installation might differ.

Universal actuator bracket must be securely installed. Drilling through the post is the strongest method.

NOTE: In all cases, the universal actuator bracket should be aligned level with a horizontal gate section.

1. Attach Universal Actuator Bracket with associated bracket (round or square post mount) as previously determined to work best with your opening method. It is recommended that the square post flush mount bracket or the round post flush mount bracket be installed for strength on opposite side of post from the universal bracket.
2. Install with carriage bolts, lock nuts and washers.
3. Tighten nuts securely.

Welding is the recommended method of securing the linear actuator mounts to the gate and hinge post. Bolt on brackets are provided and are acceptable but may require frequent service to keep tight. They must be very securely attached (i.e. carriage bolts with lock nuts and washers). Lag type bolts are not recommended. Loose or unstable linear actuator mounts will result in improper operation.



IMPORTANT CAUTIONS:

1. Do not perform any welding with the actuator cable plugged into the control board or the battery connected. Serious damage to the control board and/or battery may occur if attempted.
2. Use control box as a template to determine mounting screw locations and then attach screws and slide on control box. Do not attempt to hold control box and drill mounting holes. This could damage the preinstalled components.
3. Always disconnect the battery power from the control board using the Plug N Go harness prior to wiring any devices to the control board.

4 Attach Actuator Bracket to Universal Actuator Bracket

The actuator bracket has a 3/8" pre drilled hole that the linear actuator will mount to. This is the pivot point for the linear actuator. In all cases, the universal actuator bracket should be aligned level with a horizontal gate section. (see Mounting Site Review)

For a Pull to Open installation - the pre-drilled hole must be located 5" behind the gate hinge and 8" to the inside of the property.

For a Push to Open installation - the pre-drilled hole must be located 7" in front of the gate hinge and 4" to the drive side of the hinge.

These dimensions are measured from the center of the gate hinge (pivot point).

Hardware needed:

- two 3/8" x 2 1/2" shoulder bolts
- two 3/8" USS flat washers
- two 3/8 nylon lock nuts.

1. Attach actuator bracket to universal actuator bracket.
2. Verify that actuator bracket pivot hole dimension is located in the correct position see page 10 for dimensions.
3. Tighten bolts securely.

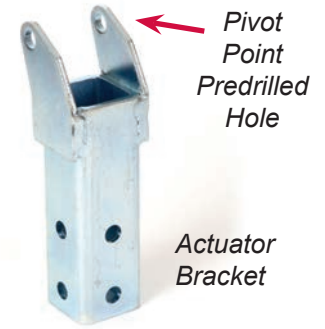

5 Install Linear Actuator to Actuator Bracket

The actuator can be mounted in two different positions as shown. Installing the actuator on its side can allow for hiding it behind a cross member in the gate frame. The gates below are shown in the closed position.

1. Install nylon washers and bronze bushings into rear of linear actuator.
2. Install the linear actuator into actuator bracket
3. Secure the linear actuator in place using 3/8 x 2 1/2" shoulder bolt and two 3/8 SAE washers.
4. Use 3/8 nylon lock nut to secure, tighten firmly.

Actuator should swing freely, DO NOT OVER TIGHTEN!

CAUTION: If mounting actuator on its side, ensure actuator case does not come in contact with any objects. Mount as shown so that wide part of motor case and cable is away from gate.



6 Install Gate Bracket to Linear Actuator

Install manual release pin, gate bracket and manual release clip to linear actuator extension rod end.



7 Install Gate Bracket to Gate (Pull to Open Only)

To determine where the gate bracket will be installed follow these steps: The linear actuator should be connected to the actuator bracket at this point. **NOTE - The linear actuator was shipped from the factory set to the fully retracted position.**

1. Swing gate to the fully open position.
2. Now open gate another couple of inches (the gate will never open more than this position). The gate can be adjusted later to open a little less if needed.
3. Swing linear actuator around (should swing freely) in a level position to meet the fully open gate. This is where you should install the gate bracket on the gate.
4. Mark the location of the 1/4" holes for the mounting bracket. (see figure)
5. Remove pin and clip from bracket.
6. Attach bracket to gate (if using a light weight tubular farm gate use gate support bracket for support). Use the 1/4" x 2 1/2" or 3 1/4" tap bolts depending on gate thickness, four 1/4" flat washers and two 1/4" nylon lock nuts. Tighten securely.
7. Attach actuator to the now secured gate bracket using manual release pin and clip.
8. The gate should now be fully opened with the actuator attached.
9. Verify that linear actuator is level and all pieces have been installed correctly.



Installing Gate Bracket to Gate for Push to Open configuration

Procedure is identical to the steps for Pull to Open except the gate will be in the fully closed position. For a push to open configuration, you will need to reverse the operating direction for the gate on the control board.

8 Preparing Sentry Control Box for Installation

The control box has two holes in the bottom of the box providing access to the wire compartment. The large hole is for the actuator cable and the smaller hole is for the charge device cable.

Install the provided cable gland into the small hole as shown here.

Cable Gland



9 Install Sentry Control Box

The control box should be installed in a location that will not require the eight foot linear actuator cable to be spliced. If the cable must be spliced, refer to the splicing instructions below. The most common location would be on a fence or wall adjacent to your gate. Avoid placing the control box behind solid metal objects that might interfere with the receiver reception. The antenna for the receiver is located inside the control box and this could reduce the operating range.

1. Use control box as a template to determine and mark the mounting screw locations using the 4 mounting holes shown in figure here.
2. Drill mounting holes for screws **DO NOT ATTEMPT TO HOLD THE CONTROL BOX IN PLACE WHILE YOU DRILL THE MOUNTING HOLES.** This could damage the preinstalled components.
3. Attach the 4 #12 hex head self tapping metal screws.
4. Mount the control box on the screws.

Verify the structure the control box is mounted on is sufficient enough to hold the control box and battery securely.

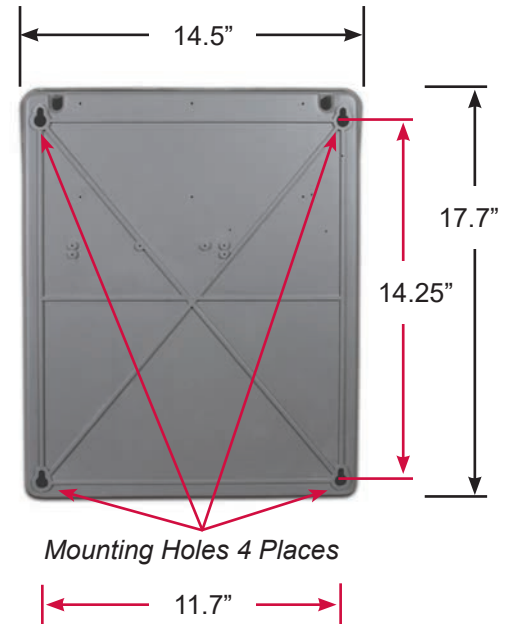

Splicing for Sentry 300 S Linear Actuator Cable (if needed)

The Sentry linear actuator comes with 8 feet of cable. Avoid splicing this cable if possible. If the control box must be located in such a way that splicing is required follow the guidelines below to avoid problems. Determine the length of additional linear actuator cable needed and either build it yourself or visit www.sentrygateopener.com for ordering the length of extension cable needed.

1. Locate the linear actuator 8 pin connector. Measure 18" from connector and mark.
2. Cut cable at the 18" mark. This will allow enough cable to be spliced and placed in the wire compartment.
3. Bring extension cable into control box and splice 5 wires using wire nuts.
4. Use approved weather tight electrical junction box for the splice located outside the control box.
5. Conduit should be used between junction box and control box. Control box knock out is for 1/2" conduit.
6. The extension cable must consist of 5 wires, 2 fourteen gauge wires and 3 eighteen gauge wires.
 - Red wire with white stripe – 14 gauge (distance added is greater than 50 feet use 12 gauge)
 - Black wire with white stripe – 14 gauge (distance added is greater than 50 feet use 12 gauge)
 - Orange wire – 18 gauge (distance added is greater than 50 feet use 16 gauge)
 - Green wire – 18 gauge (distance added is greater than 50 feet use 16 gauge)
 - White wire – 18 gauge (distance added is greater than 50 feet use 16 gauge)
7. With extension cable now in the junction box strip and prepare to splice to linear actuator cable.
8. Route linear actuator cable into junction box and splice using wire nuts.



NOTE: Cable splice must be water tight to keep moisture away from splices and prevent problems

10 Sentry Plug N Go Harness

The Plug N Go Harness comes preinstalled and should be plugged into the bottom of the charge controller. Plug is color coded. Red connects to positive battery post and Black connects to negative battery post. Once connected, place harness into wire compartment to prepare for battery installation.



Charge controller connector

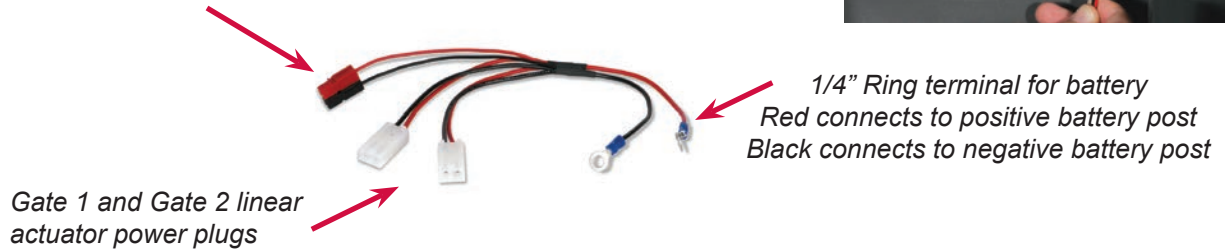

11 Install Battery

BATTERY REQUIRED FOR OPERATION *(Battery not included)*

Recommended battery type - 12-volt, Group U-1; sealed (maintenance free); 30 amp hour minimum. This battery is sometimes described as a non-spillable lawn tractor battery. Battery physical size must not exceed 9" wide, 7" tall and 5 3/4" deep.

The Plug N Go harness has two 1/4" ring terminals to connect to bolt type battery post.

CAUTION - Do not install wet cell battery into control box; this type of battery usually has removable caps used for service and will vent corrosive fumes into control box.



1. Install the battery into the battery compartment.
2. Connect O ring terminals from harness to the battery.

NOTE: Red wire to positive post of battery
Black wire to negative post of battery

3. Tighten the bolts securely (bolts should be supplied with the battery).

12 Install Charging System - AC or Solar

For AC Charge Option - Install Transformer

Supplied with opener

The USAutomatic transformer (PN520008) supplied is a low voltage UL approved transformer for this type of application. The transformer is equipped with a DC plug for easy connection to the charge controller and can easily provide 575 cycles of operation a day without decreasing the battery charge. In the event AC power goes out the opener will operate for weeks on the battery (if cycles per day are below 20) before needing service. Accessories connected to the opener are critical. Always use Solar Friendly accessories to help avoid premature battery failure in cases of power outages. **TRANSFORMER MUST NOT GET WET.**

1. Loosen cable gland nut and route the cable from the charge device into the control box (see figure). Ensure that DC plug can reach the charge controller "Power In" connector.
2. Tighten cable gland nut to hold cable in place.
3. Connect the transformer to an approved electrical receptacle.

NOTE: The 110 VAC receptacles should be installed by a qualified electrician, per local building codes.

If replacement becomes necessary visit www.sentrygateopener.com to order, part number 520008. Failure to use the proper transformer can damage the charge controller.



For Solar Charge Option - Install the Solar Panel

Optional Solar Panel Kit Part Number 520015 - not included

The location of the solar panel is critical for proper battery charging. The panel needs to face a South to Southwest direction and be installed at the angle of the supplied solar panel bracket. For proper operation the panel must have unobstructed sun. The Solar Panel needs to be mounted so that it receives full sunlight. Even a small amount of shade or blockage will cause the Solar Panel to cease charging. Something as tiny as a fingertip shadow will affect the Solar Panel.

Optimizing Solar Panel Location

The charge controller senses the charge method installed (AC or Solar) and charges the battery at the optimum charge rate. The solar panel outputs voltage and current to charge the battery. This output voltage will vary slightly as the sun passes over throughout the day. The charge controller can be used to optimize this output voltage.

- To use this feature identify time of day for the maximum solar radiation (typically around 2 pm).
- Face the panel toward the sun and observe the "External Power" light on the charge controller, adjust the panel until light comes on and secure in that position.

NOTE: Depending on the time of year and your exact location the output voltage required to illuminate "External Power" light may not be possible. This does not indicate a problem. In this case set panel to face a Southwest position and verify "Solar Power" light is on. Battery is being charged.

For additional information regarding Solar Charging, see Appendix A of this manual.



13 Connect Charge Device to Charge Controller

(Transformer or Solar Panel Kit)

The Sentry gate opener charge controller accepts inputs from either the supplied AC transformer or the optional solar panel. The transformer and solar panel come with a DC plug for easy installation. Once the charge device is selected and installed connect the DC plug into the charge controller “Power In” located in the upper right corner of the charge controller.

If charge device cable needs to be extended to reach the charge controller see appendix B of this manual.



14 Charge Controller Operation Check

Once the charge device is plugged into the charge controller verify the following:

Transformer:

1. Charge light flashes for 3 seconds and goes off
2. External power and detection lights come on
3. Detection light stays on for 3 seconds, then charging light comes on

Solar Panel:

1. Charge light flashes for 3 seconds and goes off
2. Solar power and detection lights come on
3. Detection light stays on for 3 seconds, then charging light comes on

If External Power or Solar Power LED is on and the Detection LED is on, the battery is not connected to the charger. Verify Red/Black connectors are plugged into the bottom of the charger as shown above.

NOTE: Most batteries will not be completely charged when first connected and the charging light should come on when charge controller is first connected. The fully charged light will come on once battery is fully charged.

When using a solar panel, the charge controller is designed to only charge the battery when there is enough sun to do so. If there is no sun, the lights on the charge controller should be “OFF”. This feature reduces the drain on the battery in solar installations. If transformer is installed lights are operational all the time.

15 Install Linear Actuator Cable

With the control box installed route the linear actuator cable into the bottom of the control box using the 1 1/4" hole in the rear bottom. Slide the hole plug that is installed on the linear actuator cable into the control box hole and snap in place.

If cable length is excessive, coil up and place in the wire compartment of control box. Ensure the length allows for connection to the Sentry control board Gate 1 connector.

16 Sentry Plug N Go Harness Final Installation

At this point verify the following items have been completed:

- ✓ Linear actuator installation is complete.
- ✓ Control box is securely installed.
- ✓ Plug N Go harness is connected to the charge controller.
- ✓ Plug N Go harness is connected to the battery.
- ✓ Battery is installed in the battery compartment of control box.
- ✓ Charge device cable is routed into control box and connected to the charge controller.
- ✓ Linear actuator cable is routed into control box.

Verify the above items have been completed correctly before continuing. If necessary, correct before proceeding. If completed, proceed with the following steps:

1. Locate the power connector attached to the linear actuator cable (red and black wires).
2. Connect it to one of the Plug N Go harness linear actuator power plugs. These connectors are designed so that incorrect connection is not possible and it does not matter which connector is used.
3. Locate the linear actuator cable 8 pin plug.
4. Connect it to the Gate 1 connector located on the Sentry Control board.
5. Securely snap in place.
6. Once all connections are made place wires in wire compartment.

NOTE: In case of an emergency, the Gate 1 or Gate 2 connector can be removed at anytime from control board to stop gate from moving.

This completes all cable connections and cable routing into the control box.

Sentry Control Board Information

The Sentry control board is capable of operating two gates. If your installation is a single gate you can operate the gate on the Gate 1 or Gate 2 connector. Set control switch "ON" for the connector being used. The Sentry gate opener was shipped with the receiver and entrapment siren already connected to the control board; these connections are plugs that can easily be disconnected.

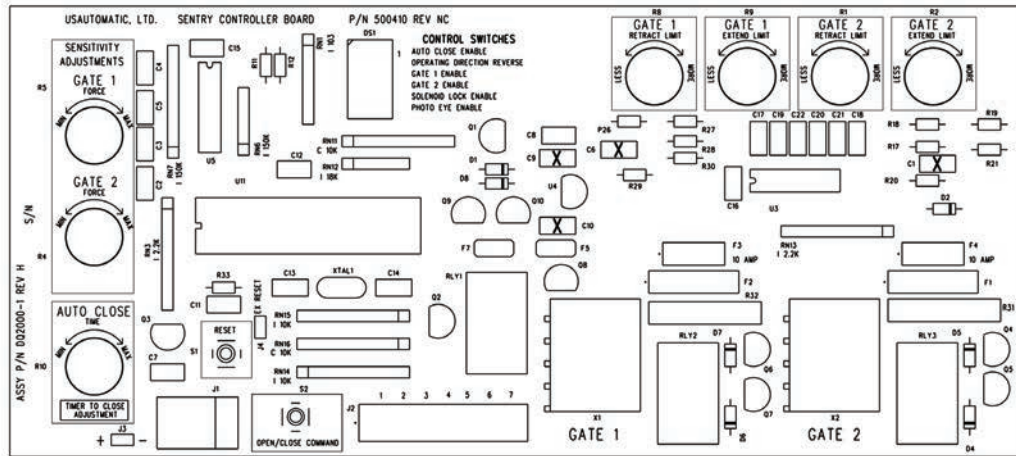

Sentry Control Board

17 Sensitivity Adjustments and Entrapment Alarm

Gate 1 and Gate 2 sensitivity adjustments are located on the left edge of the control board.

Sensitivity is the primary safety control designed into the control board. The adjustment dials control the amount of force the gate can apply to an object before the gate will stop and reverse direction. If the gate senses an obstruction it will reverse direction. If it senses a second obstruction before reaching the fully open or closed position the gate will shut down. The entrapment alarm which is preinstalled in the control box will sound.

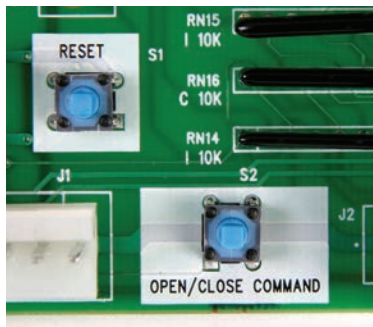

Reset Button

Entrapment alarm will continue for 5 minutes then shut off. The entrapment alarm can be reset by pressing the "Reset" button on the control board.

If two obstructions were detected and control board has shut down, the "Reset" button will have to be pressed to re-activate the opener.

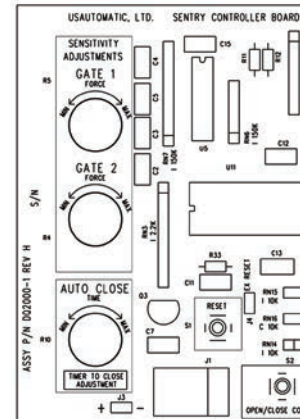

Sensitivity Adjustments

18 Adjusting Gate 1 and Gate 2 Sensitivity

Sensitivity factory setting is on position 5. This setting will work with most gates. Adjust so that when gate is stopped by an object, it stops and reverses direction.

If gate stops and reverses for no obvious reason then increase force by slightly adjusting clockwise.

If force is set too sensitive false sensing may be observed.

IMPORTANT: If adjusting for a single gate, once adjustment for that gate is set, also set the other sensitivity adjustment to the same setting. Adjusting both Gate 1 and Gate 2 sensitivity adjustments to the same setting for a single gate installation will prevent the possibility of false trigger and gate reversal.

If opener is installed to auto close and the gate current senses when closing, the gate will return to the open position and not auto close. This is a designed in safety feature required by UL325. The transmitter can be used to close the gate and return opener back to normal operation.

19 Extend and Retract Limit Adjustments (Gate open and close stop position)

Sentry control board limit adjustments are simple and easy to use. Control board has 4 adjustment dials for adjusting the desired stop positions (see figure below).

If opener was installed correctly with the actuator in the retracted position, the Retract limit is already set. You will have to adjust the extend position by turning the “Gate 1 Extend Limit More or Less” adjustment until the gate reaches the desired position.

Procedure for adjusting is as follows:

Turn the dial that matches the gate action you desire. Then cycle the gate to see the effect the adjustment made. For example, if the actuator needs to extend more then turn the “Gate 1 Extend Limit” adjustment in the clockwise direction. Then cycle gate to see the effect.

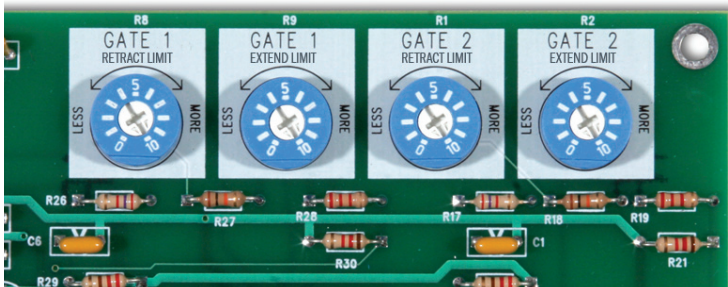

Close and Open Limit Adjustments



Extend



Retract

J2 Terminal (Accessory Wiring)

Accessories wire to the J2 connector. Insert wire and tighten screw.

J2 pin functions are as follows:

J2 pin 1 - +12 VDC output for any accessory power needed (80ma max).

J2 pin 2 - Ground connection for any accessory item.

J2 pin 3 - Open / Exit sensor input for opening the gate only (N/O connection)

J2 pin 4 - Secondary entrapment device input (N/O connection).

J2 pin 5 - Safety Reversing input (Photo Eye N/O input)

J2 pin 6 - Photo Eye Power output (+12 VDC only) connect photo eye power lead here.

J2 pin 7 - Solenoid Lock Power output (+12 VDC only) connect solenoid lock power lead here.



J2 Terminal

Control Switch Functions

Switch 1 Auto close enable – Turns on the auto close feature. Gate will close from any position.

DO NOT turn this feature on unless safety devices are installed (see page 29) for details.

Switch 2 Operating direction reverse – Turn “ON” for Push to Open installation only.

Switch 3 Gate 1 enable – Turns on Gate 1 connector

Switch 4 Gate 2 enable – Turns on Gate 2 connector

Switch 5 Solenoid Lock Enable – Turn “ON” if lock power (+12 vdc) is wired to control board.

Switch 6 Photo Eye Enable – Turn “ON” if photo eye power (+12 vdc) is wired to J2.6. Do not connect photo eye to battery or premature battery failure will occur.

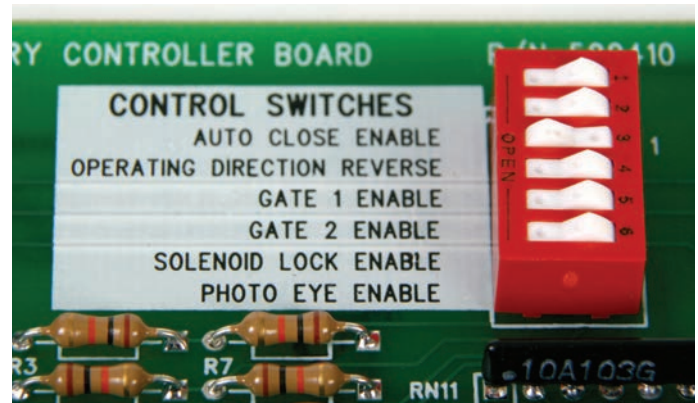

20 Operating Gate for the First Time

Before operating gate verify that the gate path is clear and free of obstructions.

Be aware to stop the gate in case of an emergency simply disconnect the linear actuator cable 8 pin plug from the control board.

Gate should be in the open position at this point.

Press the “Open/Close Command” push button. The gate should begin to close. Allow the gate to travel to the factory preset stop position.

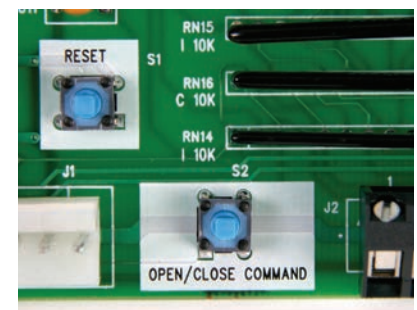

21 Making Final Adjustments

Once the gate has traveled to the stop position adjust the Gate 1 “Extend Limit More or Less” adjustment dial located on the control board.

Turn the adjustment slightly clockwise to close gate more, cycle gate and repeat until close position is correct. If gate is adjusted past the desired closed position turn the adjustment counter clockwise slightly.

Then cycle the gate to verify close position is correct.

22 Install Safety Signs

Mount the 2 included safety signs on inside and outside of the gate area so they are clearly visible.



23 Programming Transmitter and Receiver

(model 433DSR2LC):

Operating frequency 433.92 MHz.

Receiver can store up to 42 unique transmitter dipswitch code settings.



Transmitter Setup:

(It is recommended that the dipswitch code be changed from the default factory setting)

1. Open the battery compartment door and locate the dipswitches.
2. Change the dipswitches to the settings you prefer, record for future reference in the table below.

Switch Position	Switch 1	Switch 2	Switch 3	Switch 4	Switch 5	Switch 6	Switch 7	Switch 8	Switch 9
+									
0									
-									

Transmitter Left Button to Receiver Programming: *(standard Open/Stop/Close function)*

1. Press and hold the left transmitter button down. Red light on transmitter should be on.
2. On the receiver, push the P1 push-button until the green LD light comes on.
3. Release both buttons. Transmitter left button to receiver programming is complete.

Transmitter Right Button to Receiver Programming: *(Hold-Gate-Open) (Only if auto close timer is enabled)*

1. The 2-channel receiver allows for programming the P2 relay from momentary mode (default) to latching mode. Transmitter right button can be programmed to hold gate open, over-riding the auto-close feature if activated.
2. Press and hold the right transmitter button down. Red light on transmitter should be on.
3. Press the P2 push-button until the green LD light comes on.
4. Release both buttons. Transmitter right button to receiver programming is complete.

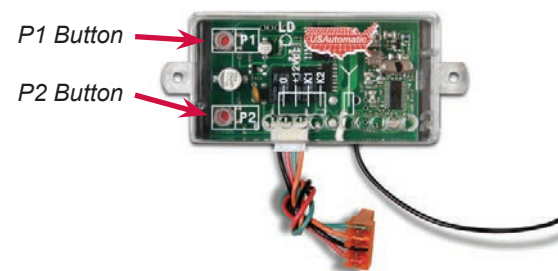

Receiver Programming - Latch Open Mode: Relay P2 programming from momentary to latching mode (to hold gate open)

1. Press the P2 push-button until the green LD light comes on, then release. Green LD light should be steady.
2. While the green LD light is on, push the P1 push-button down and release. Green LD light should be flashing. Latching mode is set.

Verifying Receiver P2 relay is programmed to latching mode:

1. Press the P2 push-button until the green LD light comes on, then release.
2. Green LD light should be flashing. If green LD light is steady, redo the Receiver Programming section above.

Resetting receiver P2 relay to momentary mode:

1. Press the P2 push-button until the green LD light comes on, then release. Green LD light should be flashing.
2. While the LD light is flashing, push the P1 push-button down and release. Green LD light should be steady. Momentary mode is set.

Erasing Single Transmitter from Receiver Memory:

The dipswitch settings of the transmitter to be deleted must be known. If known follow the steps below.

1. Set the dipswitches in a transmitter to match the switch settings of the transmitter code to delete.
2. Press and hold the left transmitter button.
3. On the receiver, push the P1 push-button until the green LED light comes on. Then release both.
4. If right button was programmed it must be deleted also. Press and hold the right transmitter button.
5. On the receiver, push the P2 push-button until the green LED light comes on. Then release both.
6. Transmitter is now erased from receiver memory.

Erasing all Transmitters from Receiver Memory:

1. Press the P2 button on the receiver until the green LD light comes on. Then release P2 button.
2. While LD light is on press the P1 and P2 buttons simultaneously and hold until the green LD light begins to blink slowly. It should blink 4 times then all transmitter codes are erased.

The transmitters provided with your USAutomatic operator contain 2 buttons. Designate one or all buttons for gate operation, if desired. The additional button may be programmed to other devices such as a garage door if frequency is compatible. If frequency is not compatible with existing product, please visit www.usautomatic.com for other solutions.

ENTRAPMENT ZONES

- Zone 1** The leading edge of the gate & catch post.
- Zone 2** Area between the gate and hinge post.
- Zone 3** The arc of the gate or gate path.
- Zone 4** The space between the gate when open and any obstruction such as fence, wall, landscaping, etc.
- Zone 5** The point where two bi-parting gates come together when closing. (Not shown below)

Every installation is unique and it is the installer's responsibility to recognize and remedy all safety concerns. Please consult a qualified dealer or the factory for a complete explanation of the remedies shown above and additional tips pertaining to your installation.

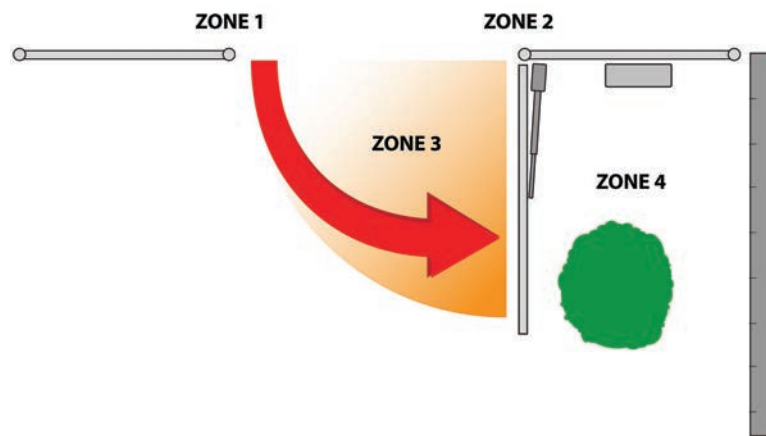

PERIODIC SERVICE

All gate operators require periodic checking and adjustments of the control mechanism for force (load), speed and sensitivity. All accessories and secondary safety devices must be checked. Secondary safety devices need to be checked at least once a month for proper operation.

Periodic checking is also advised for the following:

1. Battery terminals for corrosion, clean with baking soda solution.
2. Hinges and pivot points need to be greased.
3. Mounting bolts for correct tightness.
4. Inspect weld points for cracks or other defects.
5. Inspect wiring for cuts, nicks or other defects.
6. Inspect hinge post to ensure it is not moving or twisting.
7. Verify charge device for proper operation. Refer to charge controller operation check.
8. Verify monthly that the inside of the control cabinet remains clean and free of insects. Do not spray control board with bug spray or oil based products.
9. Opening or closing time should be approximately 16 seconds. If the time begins to increase, the battery needs to be tested.

Sentry 300 D Gate 2 Installation PN #020325

PARTS INVENTORY



Universal Actuator Bracket

Part # 610400
1 per

NOTE:
Arrow installs
toward drive.



Square Post Flush Mount Bracket

Part # 610402
1 per



Round Post Flush Mount Bracket

Part # 610404
1 per



Actuator Bracket

Part # 610406
1 per



Gate Bracket

Part # 610105
1 per



Gate Support Bracket

Part # 610120
2 per



Bronze Bushing

Part # 610530
2 per



Manual release pin

Part # 610534
1 per



Manual release clip

Part # 610535
1 per

Linear Actuator

Part # 510300
1 per



50 Ft 5 Conductor Extension Cable

Part # 630035
1 per



Junction Box

Part # 630045
1 per



Wire Nut

Part # 620320
4 per



Wire Nut

Part # 620310
4 per



3/8 x 2.5" Shoulder Bolt

Part # 610512
3 per



3/8 x 8" Carriage Bolt

Part # 610510
2 per



1/4 x 20 x 3 1/2" Tap Bolt

Part # 610522
2 per



1/4 x 20 x 2 1/2" Tap Bolt

Part # 610520
2 per



#8 x 3/4 Self tap hex screw

Part # 610615
2 per



3/8 x 16 nylon lock nut

Part # 610518
5 per



1/4 x 20 nylon lock nut

Part # 610526
2 per



3/8 USS flat washer

Part # 610514
6 per



3/8 SAE flat washer

Part # 610516
2 per



1/4 SAE flat washer

Part # 610524
4 per



Nylon washer

Part # 610528
2 per

NOTE: It is strongly recommended that the extension cable provided be installed in conduit to help protect cable from being damaged.

The Gate 2 kit contains linear actuator with 1 1/4" hole plug, 50 feet of 5 conductor cable, wire nuts, junction box and mounting hardware. The Sentry control box is equipped with two knock outs for the gate 2 linear actuator cable. One knock out is 1 1/4" and is intended for non conduit installation (not advised). The other knock out is 7/8" and designed for 1/2" conduit fitting for conduit installation (recommended). (see figure)

If conduit is being installed knock out 7/8" hole. If conduit is not being installed knock out 1 1/4" hole.

Remove the knock out that is right for your installation.



Control Box Knock Outs

Installing Gate 2 Linear Actuator

1. Install Gate 2 linear actuator using the procedure described for the Gate 1 actuator.

The linear actuator for Gate 2 comes with an 8' cable that must be cut and spliced in the following manner once linear actuator is installed.

Once Actuator is installed:

1. Locate the linear actuator cable connector and measure 18" from connector end and cut (see figure).
2. Save this 8 pin connector and pigtail for step 21 on next page.
3. Install junction box on Gate 2 hinge post below linear actuator using the 2 self tapping metal screws.

NOTE: Sentry 300 D Gate 2 kit includes 50' of extension cable, if distance between control box and junction box exceeds this distance it is recommended to purchase a cable that will not require additional splices in the cable. Visit web page to order Sentry 300 D Gate 2 extension cable www.sentrygateopener.com.

4. If conduit is being installed attach 1/2" conduit adapter to the control box 7/8" knock out.
5. Route linear actuator cable to junction box and determine length needed (see figure).
6. Cut cable longer than needed for future considerations (see figure).
7. Remove 2" of cable insulation to expose the 5 wires.
8. Caution: Do not damage internal wires.
9. Remove approximately 1/2" of insulation from each wire.
10. If installing conduit attach 1/2" adapter to junction box. If not, cut rubber knock out (supplied) to fit cable.
11. Install Gate 2 extension cable into the junction box (see figure).
12. Using supplied wire nuts connect the 5 wires matching the wire colors (see figure).
13. Do not install junction box cover until all connections have been completed
14. With extension cable now installed in junction box, route the other end of the extension cable to the control box.
15. Install wires into control box wire compartment.
16. Snap 1 1/4" hole plug into control box if conduit was not used.

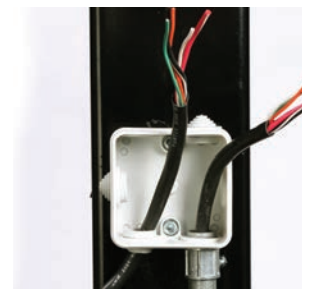

17. Cut extension cable to length allowing for future considerations.
18. Remove 2" of cable insulation to expose the 5 wires.
Caution: do not damage internal wires.
19. Remove approximately 1/2" of insulation from each wire.
20. Locate 8 pin connector and pigtail previously cut from Gate 2 linear actuator cable. Prepare wires for the splice.
21. Connect the 5 wires from extension cable to the 5 wires from the pigtail by matching the wire colors. Then secure with supplied wire nuts.
22. Roll cable and place in wire compartment.
23. Install junction box cover and securely snap in place.



Connecting Gate 2 Linear Actuator to Control Board

1. Locate the power connector attached to the linear actuator cable (red and black wires).
2. Connect it to the remaining Plug N Go harness linear actuator power plug. These connectors are designed so that incorrect connection is not possible and it does not matter which connector is used.
3. Locate the linear actuator cable 8 pin plug. Connect it to the Gate 2 connector located on the Sentry Control board adjacent to the Gate 1 connector. Securely snap in place. Once all connections are made place wires in wire compartment.

Preparing to Operate Gate 2 for the First Time

Using the "Open/Close Command" button on the control board open Gate 1. This is done because Gate 2 was just installed in the open position and now both gates should be in the open position.

Operating Gate 2 for the first time and final adjustments

1. Locate the control switches and turn on switch 4 (press down on the right side).
2. Gate 1 and Gate 2 should be in the open position if installed correctly.
3. Press the "Open/Close Command" button to close Gate 1 and Gate 2.
4. Gate 2 limit adjustment has not been made so it should stop short of fully closed.
5. Turn "OFF" control switch 3, disabling Gate 1.
6. Now use the "Open/Close Command" button to cycle Gate 2 and adjust Gate 2 close limit to match Gate 1 close position.
7. With both gates now closed, turn "ON" control switch 3 enabling Gate 1.
8. Press "Open/Close Command" to open both gates and then close, adjust limit positions if necessary.

CAUTION: To reduce the risk of injury, USAutomatic strongly recommends the installation of additional safety devices such as Photo Eye Sensors and Safety Edges. Consult an authorized installing dealer or www.Sentrygateopener.com for a complete explanation of options and see the Safety Section of this manual on pages 3 to 4.

Sentry Garage Door Receiver

Part Number 030209

The receiver provided with the Sentry gate opener operates at 433.92 MHz and might or might not be compatible with your garage door. If receiver frequency is not compatible the optional "Sentry Garage Door Receiver kit" can be easily installed in the garage.

The kit contains receiver, transformer and a wire harness that easily installs to the existing garage door. One receiver will be needed for each garage door. All existing transmitters used for garage door will continue to operate. They are not being disconnected. Mounting hardware included.

To program open receiver box cover. Place small screw driver in slot to open. Press the learn button. Then press the transmitter button that will be used to open the garage. See garage opener for connecting the 2 wires supplied.

If needed, 4 button transmitters are available at www.sentrygateopener.com part number 030212.

CAUTION: DOOR WILL OPERATE WHEN RECEIVER IS PROGRAMMED IF SIGNAL WIRES ARE ATTACHED. KEEP HANDS CLEAR OF MOVING PARTS TO AVOID INJURY



Sentry Push to Operate Wireless (Solar friendly device)

Part Number 050510

The Push to Operate transmitter is designed for outdoor wireless installation. Install to allow operation of the gate or garage by simply pressing the pad. The button is a pressure sensitive pad. Press the pad an audible tone is generated. Programming is identical to transmitter programming. Installation hardware is included.



7 Day Timer (Solar friendly device)

Part Number 550015

The optional 7 day timer can be used to open the gate at a preset time and if the auto close feature of the gate opener is being used the gate can then close automatically at a preset time. The timer is supplied with a 3 wire harness that easily wires to the control board. Connect wires from timer to control board J2 connector as follows:

- Red wire connect to J2 pin 1
- Black wire connect to J2 pin 2
- Blue wire connect to J2 pin 3



Sentry Exit Sensor (Solar friendly device)

Part Number 070310

The driveway exit sensor is a magnetic device that installs below ground beside the drive. A magnetic field is established which when interrupted by a metal object will send a signal to open the gate. This sensor is supplied with a 100 foot cable and is typically installed inside the property beside the drive to automatically open the gate when a car passes. If more than 100 foot of cable is desired do not attempt to add cable. This will only create problems. This type of sensor is not a safety device. Sensor can be ordered with longer cables.

Visit www.sentrygateopener.com for ordering information.

It is recommended to install this sensor and cable in PVC conduit.

Wire as follows: Red wire – connect to J2 pin 1
Shield (braided wire) – connect to J2 pin 2
Black wire – connect to J2 pin 3



Sentry Photo Eye (Send and receive)

Part Number 550012

The photo eye is a secondary safety device. It produces a beam between the 2 units. When the beam is broken it will keep the gate from closing. It requires wires to be connected to both units (20 gauge) for operation. Typically a swing gate needs two sets of photo eyes for the best area protection (see figure below).

One set of photo eyes pointing across the drive on the outside of the hinge post (A). The second set mounted across the drive at the point where the gate is fully opened (B). The photo eye must be installed where the gate does not break the beam. The primary unit (Receiver) should be installed close to the control box. It requires 4 wires to be installed from the unit to the control box. The second unit (Transmitter) should be installed on the opposite side of the drive. It requires 2 wires to be installed from the unit to the control box. The two units must face each other to establish the beam (maximum distance 40 feet).



Transmitter Receiver

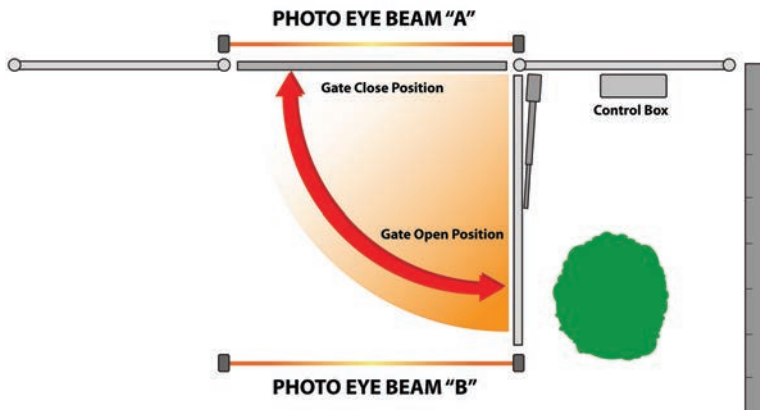

Photo Eye Installation / Wiring

Select a proper installation site, where the transmitter and the receiver can be along the same line and at the same height. Remove the cover from both units. Attach back plate to the installation site using mounting holes in back plate.

If conduit is being used (recommended) knockouts are provided in the unit for 1/2" conduit fitting. Install wires into unit and strip 1/4" of insulation to prepare for wiring connections.

Connect both conduits to a weather tight junction box. Then connect an additional conduit between the junction box and Sentry control box. The Sentry control box has knockouts for the conduit. Verify which knockout is available for the photo eye conduit. Pull wire into Sentry control box wire compartment.

Transmitter wiring – 2 wires will be connected to the transmitter.

First wire connects to ground ("GND") terminal and the second wire connects to "+12V" terminal.

Receiver wiring – 4 wires will be connected to the receiver.

First wire connects to "+12V" terminal, second wire connects to "NO" terminal, third wire connects to the "GND" terminal and the fourth wire connects to the "COM" terminal.

Connect these wires to the Sentry Control board as follows:

+12V –	J2 pin 6	(2 wires one from each unit)
GND –	J2 pin 2	(2 wires one from each unit)
COM –	J2 pin 2	(1 wire from receiver unit)
NO –	J2 pin 5	(1 wire from receiver unit)

NOTE: Sentry control board switch # 6 must be turned "ON".

Electric Gate Lock

Part Number 070510

The USAutomatic Electric Gate Lock works with an automatic gate operator to securely lock the gate into position without having to step out of a vehicle. The USAutomatic Electric Gate Lock is wired into the gate operator control box, and when an input device such as a transmitter or keypad is used to open the gate, the USAutomatic Electric Gate Lock disengages. The gate will then swing open. When closing the gate, the gate retracts and the gate lock automatically engages to secure the gate in the closed position.

- Rugged steel housing and catch assembly
- Strike pin removable for emergency release
- 12 vdc operating voltage
- Bolt-on Installation
- Mounting hardware included
- Low amperage, rack and pinion driven
- Spring loaded self-latching locking mechanism



Wireless Keypad

PUK code _____

Part Number 050520

This tamper-resistant, weatherproof, programmable Multi-code Wireless Keypad can be mounted outside your gate and offer convenient access without having to carry a transmitter.

Compatible with all USAutomatic wireless products.

- long battery life
- 24 access code
- 19683 code combinations
- 433.92 MHz
- 1 year Warranty



Metal Wireless Keypad

PUK code _____

Part Number 050550

This metal tamper-resistant, weatherproof, programmable Multi-code Wireless Keypad can be mounted outside your gate and offer convenient access without having to carry a transmitter.

Compatible with all USAutomatic wireless products.

- rugged metal housing
- stainless keys that illuminate on button press
- long battery life
- 24 access code
- 19683 code combinations
- 433,92 MHz
- 1 year Warranty



Programming Your Wireless Keypad

Part Number 050520 (plastic) and 050550 (metal)

This tamper-resistant, weatherproof, programmable Wireless Keypad can be mounted outside your gate and offer convenient access without having to carry a transmitter.

Terms to understand:

Access Code – The 2 to 5-digit code used to open the gate (24 unique codes are possible). If access code is less than 5 digits it requires the # sign after code is entered. Example: “2 #.” If code is 5 digits the # sign is not required. **CAN NOT BE THE SAME AS THE MASTER PASSWORD.**

Master Password – The 5-digit code used to access programming features. Factory default is “11111”. This should be changed for security reasons. **NOT USED TO OPEN GATE AND CAN NOT BE THE SAME AS THE ACCESS CODE.**

Relay 1 – The receiver has 2 relays. P1 (relay 1) is pre-wired to the J1 connector.

Relay 2 – The receiver has 2 relays. P2 (relay 2) is pre-wired to the “Open/Free Exit” on J1 connector.

Keypad Security Code (Dip Switch Code) – This code makes your keypad unique to your installation. Keypad does not have dip switches like the transmitter; instead it has virtual dip switches which must be programmed.

PUK Code – “Password Unblocking Key.” The PUK code is located inside the keypad and is needed when the master password has been lost. Record in space above for future reference. Must be 5 digits long.

“ * ” **Key** – located on the keypad is used to cancel last command entered.

Red Light Blinks – When blinking, the keypad is sending a signal to the receiver. Valid access code was entered. This is the Blue 5 key on the metal keypad.

Note: Do not install keypad until “Create Communication with Receiver P1 (relay 1)” has been completed.

Programming the Keypad for Operation – Note metal keypad uses A or B in place of * and #.

Create Access Code: (Code you use to operate the gate) ***CAN NOT BE THE SAME AS THE MASTER PASSWORD!**

1. Enter the Master Password “11111”. (this is the factory default master password).
2. Enter “9” If correct, 2 short beeps (if 1 long beep is heard, start over with step 1).
3. Enter the new Access Code (up to 5 digits), if less than 5 digits, “# or B” key is required.
4. Enter “9”
5. Enter the new Access Code again to verify.
6. Enter “1”. If this access code is for P1 (relay 1) Enter “2” if this access code is for P2 (relay 2).
7. If correct, 2 short beeps (if 1 long beep is heard, start over with step 1).
8. Continue with “Create Communication with Receiver” to complete programming. (pg 32)

NOTE: Step 6 above allows you to select a unique frequency (1, 2, 3, 4) for the access code you are creating. Keypad can be programmed with 4 different access codes each having a unique frequency. This is used when multiple gates are within range of the keypad. Create an access code using 1 in step 6 for one gate. Create an access code using 2 in step 6 for the second gate. This allows one keypad programmed with 2 access codes to operate 2 different gates within range or two keypads can be installed on 2 different gates without interfering with each other. If 4 gates were involved then 3 and 4 could be used in step 6. Also used to create a unique access code to activate the hold open feature offered with P2 (relay 2).

Create Communication with Receiver: *for P1 (relay 1) access code:

1. Carry keypad to receiver location for programming.
2. Enter Access Code for P1 (relay 1) on the keypad and continue to press the last key entered (red light blinks).
3. Press P1 (learn button) on the receiver until LD (green light) comes on and relay clicks.

Create Communication with Receiver: *for P2 (relay 2) access code:

1. Carry keypad to receiver location for programming.
2. Enter Access Code for P2 (relay 2) on the keypad and continue to press the last key entered (red light blinks).
3. Press P2 (learn button) on the receiver until LD (green light) comes on and relay clicks.

Programming New Master Password: Once created record here for reference _____

1. Enter the Master Password "11111".
2. Enter "8" If correct, 2 short beeps (if 1 long beep is heard, start over with step 1).
3. Enter the Master Password (up to 5 digits), if less than 5 digits, "# or B" is required.
4. Enter "8"
5. Enter the Master Password again to verify.
6. Press "8" If correct, 2 short beeps - New Master Password is set (If 1 long beep is heard, start over with step 1).

Programming Master Password Back to Factory Default: (11111)

1. Enter "11111".
2. Press "8" (long beep).
3. Enter PUK code. (PUK must be 5 digits).
4. Press "8".
5. Enter PUK code to confirm.
6. Press "8" (2 beeps) Master password reset complete.

Changing Keypad Security Code:

This keypad has a virtual dipswitch used to create your Security Code. The virtual dipswitch contains nine 3-position switches. To ensure neighboring keypads do not interfere with each other, the virtual switches should be positioned in a random pattern, using the following procedure.

Example of random positioning of the virtual dipswitches to create a Security Code is shown below. To enter the Security Code, enter the dipswitch number, followed by the dipswitch position character.

The Security Code would be entered as: 1# 20 3* 4* 5# 6* 7# 80 9*

Dipswitch Position	Switch 1	Switch 2	Switch 3	Switch 4	Switch 5	Switch 6	Switch 7	Switch 8	Switch 9
#	X				X		X		
0		X						X	
*			X	X		X			X

Use table below to create your random security code and follow steps below to program your keypad.

Dipswitch Position	Switch 1	Switch 2	Switch 3	Switch 4	Switch 5	Switch 6	Switch 7	Switch 8	Switch 9
#									
0									
*									

1. Enter the Master Password.
2. Enter "6" If correct, 2 short beeps (if 1 long beep is heard, start over with step 1).
3. Enter the Security Code created in the previous table. If correct, 2 short beeps after each switch number and switch position combination is entered.
4. Enter "#"
5. Enter "6"
6. If correct, 2 short beeps (if 1 long beep is heard, start over with step 1).

Learning Access Codes in Receiver:

Create Communication with Receiver Relay 1:

1. Carry keypad to receiver location for programming.
2. Enter the Access Code for relay 1 on the keypad and continue to press the last key entered (red light blinks).
3. Press P1 (learn button) on the receiver until LD (green light) comes on and relay clicks.

Create Communication with Receiver Relay 2:

1. Carry keypad to receiver location for programming.
2. Enter the Access Code for relay 2 on the keypad and continue to press the last key entered (red light blinks).
3. Press P2 (learn button) on the receiver until LD (green light) comes on and relay clicks.

Deleting Single Access Code:

1. Enter the Master Password.
2. Press the "7" key. If correct, 2 short beeps (*if 1 long beep is heard, start over with step 1*).
3. Enter the Access Code to be deleted.
4. Press the "7" key.
5. Reenter the Access Code to be deleted.
6. Press the "7" key. If correct, 2 short beeps (*if 1 long beep is heard, start over with step 1*).

Deleting All Access Codes:

1. Enter the Master Password.
2. Press the "7" key. If correct, 2 short beeps (*if 1 long beep is heard, start over with step 1*).
3. Reenter the Master Password.
4. Press the "7" key.
5. Reenter the Master Password.
6. Press the "7" key. If correct, 2 short beeps (*if 1 long beep is heard, start over with step 1*).

Terms and Definitions

Control board - See page 19

Receiver - See page 22

Transmitter - Hand held unit with 2 buttons, used to operate the gate, sends signal to receiver when button is pressed see page 22.

Linear Actuator - Connected to gate and hinge post, contains the motor, gearbox.

Connector - Control board has Six, two white 8-pin connectors (X1 and X2) are used to connect linear actuator to control board and one 7-pin connector (J2) (located bottom center of control board) for accessory wiring, two 2 pin header (J3, J4) for entrapment siren & external "Reset" and one four pin header (J1) for receiver.

Push Button - Two are located on the control board. "Open/Close command" used to operate the gate and the "Reset" used to reset the control board after current sensing twice before a limit is reached see page 21.

Control Switches - Used to turn "ON" or "OFF" specific control board functions see page 21.

Sensitivity adjustments - Located on the control board see page 19. These adjustments are the primary safety feature. If the gate comes in contact with an object it will stop and reverse. These adjustments control the amount of force applied to an object before reversing the gate.

Charge Controller - Located inside the control box see page 17. This is the battery charger. The input power for this device can be either from the transformer (supplied) or the Sentry Solar Panel (Part #520015).

Transformer - This device connects to a 110 VAC electrical outlet and converts it to a low AC voltage that can be connected to the charge controller to provide continuous charging of the battery.

Retract and Extend Limit - This refers to the fully open or closed position and are adjusted on the control board see page 20.

Entrapment Siren - If the control board sensitivity circuit senses an obstruction it will reverse the gate and if a second obstruction is detected before the gate reaches a fully open or close limit the control board will shut down the opener and sound the entrapment alarm for five minutes or until the "Reset" button is pressed.

Gate 2 - is defined as the gate on the other side of the drive from the control box.

Problems

1. Gate 1 or Gate 2 will not operate. Single gate installation.
2. Gate 1 or Gate 2 will not operate. Dual gate installation.
3. Gate 1 and Gate 2 will not operate. Dual gate installation.
4. Single or Dual gate installation opens or closes very slow.
5. Single or Dual gate installation will not automatically close.
6. Single or Dual gate installation automatically opens instead of automatically closing.
7. Gate begins to open or close, but stops and reverses after a couple of seconds.
8. Pressing the “RESET” button only, causes the gate to operate (open, close and stop) acts like transmitter.
9. Transmitter (Remote control) will not operate the gate.
10. Photo eye or other safety accessory will not reverse the gate when closing.
11. Transmitter operating range seems short
12. Gate 1 or 2 opens and closes, but stop positions have changed
13. Gate 1 or Gate 2 only operates in one direction

1. My single gate will not operate: (connected to Gate I or Gate II)

1. Open control box cover and locate the “Open/Close Command” push button and press it to operate the gate.
2. Press the “Reset” push button located above the open close command, then push the “open/close command” push button to operate the gate.
3. When pressing the “open/close command” push button, listen for a clicking sound, if click is heard then verify:
 - A. Verify the correct control switch is “ON” corresponding to the Gate 1 or Gate 2 connector the linear actuator is connected to.
 - B. If step A switch setting was correct, then the problem is most likely low power.
 - C. Low power can be caused by two things – Low battery voltage or a bad connection at the battery. Battery will need to be load tested to verify it is good. Replace battery or correct connection problem at battery.
4. Remove the receiver connector plugged into the J1 connector. Press the “Open/Close Command” button and verify gate operates. Reconnect Receiver and test again.
5. Disconnect linear actuator connector from the control board and connect it to the other (Gate 1 or Gate 2) connector on the control board. Then set the corresponding control switch to the “ON” position. Press the “Open/Close Command” button and verify gate operates. If gate operates on the other connector that is acceptable.
6. If gate still does not operate please call the Sentry support staff for more information.

<p>2. Gate 1 <u>or</u> Gate 2 will not operate. Dual gate Installation</p>	<ol style="list-style-type: none"> 1. These instructions are for the failure of one gate to operate in a dual gate installation. 2. Identify the gate that will not work and check the control switch for that gate and verify that it is turned “ON”. 3. Swap the Gate 1 and Gate 2 linear actuator connectors on the control board. If problem moves to other gate then the control board is bad. 4. If problem remains in the same gate then the problem is either a wire problem or linear actuator problem. Since it is a possible wire problem we need to check the following: <ul style="list-style-type: none"> A. Wire harness for cuts, nicks or bad splices if splice exist. B. If gate with problem is the gate located on the other side of drive from control box (Gate 2) the cable under the drive needs to be verified good. This is done by using a voltmeter and going to the junction box located below the Gate 2 linear actuator. Locate the red wire with white stripe and the black wire with white stripe and then operate the gate and check voltage on these two wires (expect 12 VDC). C. If voltage is present when gate should be operating then the problem is most likely the linear actuator. D. If voltage is not present when gate should be operating then move back to the control box side and check voltage on same two wires located in the wire compartment. E. If voltage is present on the control box side of drive then the cable in the ground must be damaged. F. If voltage is not present in the control box then we have missed something in steps 2 or 3, recheck.
<p>3. Gate 1 <u>and</u> Gate 2 will not operate. Dual gate installation</p>	<ol style="list-style-type: none"> 1. These instructions are for the failure of both gates to operate in a dual gate installation. 2. Verify that control switches 3 and 4 are turned “ON”. 3. Verify the red and black wires on the Plug N Go harness are connected to the battery correctly. Red connects to positive and black connects to negative post on the battery. 4. Verify that the battery is charged, press the “Open/Close Command” push button, if a clicking sound is heard from the control board then most likely the battery is dead. Have the battery load tested to verify it is bad. 5. If battery checks good (passed the load test) then the control board is most likely the problem. To think that 2 motors have gone bad would not make sense but is also a possibility.

<p>4. Gate 1 or Gate 2 (Gate 1 and Gate 2 if dual gate) operating speed has slowed down</p>	<p>When the gate is running slow, the reason is low power. The Sentry charge controller does not output any voltage or current when disconnected from the battery, you cannot check the charge controller by disconnecting from battery and measuring output voltage. To check charge controller output, disconnect from battery, measure battery voltage and note. Reconnect charger and monitor battery voltage it should rise above the battery voltage noted above.</p> <p>Two things need to be considered.</p> <ol style="list-style-type: none"> 1. Battery condition (replace or charge) 2. the 1/4" ring terminals located on the Plug N Go harness which are connected to the battery. The ring terminals can become corroded and need replacing over time. <p>Remove battery and have it load tested at a battery shop. Replace if bad.</p>
<p>5. Single or Dual gate installation will not automatically close</p>	<p>If control switch number 1 is turned "ON" then the gate will only auto close from the fully open position.</p> <ol style="list-style-type: none"> 1. Locate the "Open/Close Command "push button; press the button to verify that the gate will close. If gate closes correctly then proceed to the steps below. If gate will not close go to step 5. 2. Verify that control switch number 1 is turned "ON". Gate must be cycled once switch is turned "ON" for control board to recognize switch setting. 3. If your installation is a single gate verify which linear actuator connector (Gate 1 or Gate 2) on control board you are using. Then verify that the control switch for that Gate is turned "ON" and the other is turned "OFF". 4. If photo eye or other safety accessory is connected to J2 then we need to verify correct operation of the accessory. To determine if this might be the problem disconnect the wire that is connected to J2 pin 5 and cycle gate to see if problem persists. If gate auto closes, accessory disconnected is holding gate open verify wiring and operation of device. 5. The receiver P2 relay could be set for latch open mode. To verify: press the transmitter button 2 one time, then press the transmitter button 1 one time and see if gate closes. If gate closes, then the hold open mode was enabled. For more information see page 22.

<p>6. Single or dual gate installation gate auto opens instead of auto closing</p>	<ol style="list-style-type: none"> 1. In this condition the open time can be controlled by adjusting the auto close timer adjustment. 2. If installed in the pull to open configuration then control switch number 2 should be turned “OFF” verify it is. If installed in the push to open configuration verify switch is turned “ON”. 3. Gate is trying to close too far. Readjust close limit adjust for gate 1 or gate 2 to the correct stop position. 4. If time before auto opening cannot be adjusted and occurs in a couple of seconds after closing then the close limit adjustment of one or both gates is misadjusted. The feature that is causing the gate to open is the current sense circuit on the control board. The gate is trying to close farther than possible and it has traveled to the full extent of the linear actuator. Verify that linear actuator harness has no cuts or nicks. 5. Verify correct installation of the universal actuator bracket. Possible cause is incorrect installation of the gate bracket or linear actuator bracket. Verify and correct as required.
<p>7. Gate begins to open or close and stops and reverses after a couple of seconds</p>	<ol style="list-style-type: none"> 1. This occurs when the sensitivity circuit on the control board senses an obstruction. Verify that the gate is not obstructed by some object at the point where it reverses. Could also be due to hinges binding or gate contacting ground. 2. This is an adjustable feature and the cause could simply be an adjustment of the Gate 1 or Gate 2 sensitivity. Turn the sensitivity adjustment toward a minimum setting and always set the Gate 1 and Gate 2 adjustment to the same setting on a single gate installation. In dual gate installation adjust both as necessary.
<p>8. Pressing the “RESET” button only, causes the gate to operate (open, close and stop) acts like transmitter.</p>	<ol style="list-style-type: none"> 1. This problem is probably due to a bad receiver. 2. To isolate this disconnect the J3 connector from the control board. 3. With J3 disconnected see if Reset button causes gate to operate. If gate no longer operates when Reset is pressed then the receiver was the cause. 4. Connect J3 back to Sentry control board and see if problem returns. If problem returns then the receiver is bad.

9. Transmitter (remote control) will not operate the gate

1. Remove the J1 connector from the control board and then reconnect, press transmitter button to verify operation.
2. Open the control box and press the transmitter button to operate the gate, listen closely for a clicking sound coming from the receiver. Click should be heard when the transmitter button is pressed if transmitter and receiver programming is correct and they are working correctly a sound should be heard.
3. If click was not heard verify that "Programming transmitter and Receiver" steps on page 22 have been completed.
4. If clicking sound was not heard, verify that transmitter battery is good, replace if necessary.
5. If click was not heard verify that transmitter dip switches were not changed after initial programming on page 22, if so then reprogram transmitter to receiver following steps on page 22 or set back to original setting recorded on page 22.
6. If click was not heard verify that receiver has power applied to it by pressing the P1 button on receiver and holding down until green light comes "ON" then release P1. If light comes "ON" then power to unit is correct. If light does not come "ON" verify that connector J1 is connected to control board correctly. If light does not come "ON" and power to receiver is good then receiver is possibly bad.
7. If clicking sound was heard then the problem might possibly be the control board. Verify control board is not the problem. Perform the following steps:
 - A. Remove the J1 connector from the control board
 - B. With J1 removed use a small screw drive to short the center 2 pins on J1 together. When these 2 pins are connected the gate should operate. If not the control board has a problem perform the next step to determine the extent of the problem.
 - C. Connect a short wire to the J2 connector pin 2 (J2 pin 1 is located on the left end of J2) and then touch J2 pin 3 with the other end of the wire gate should operate, if not control board is bad.
 - D. If gate operates then remove the wire from J1 pin 2 on the receiver connector and connect it to J2 pin 2, verify operation.

<p>10. Photo-eye or other safety accessory will not reverse the gate when closing or hold the gate open</p>	<ol style="list-style-type: none"> 1. The first thing to check is the accessory wiring. See accessory wiring information on page 21. 2. Accessory being used should be wired with the N/O wire connected to J2 pin 5 on the Sentry control board. 3. Verify the control switch “Operating Direction Reverse” switch is set in the correct position, Pull to Open switch is OFF. 4. Connect a wire to J2.5 then start the gate closing and then touch the free end of this wire to J2.2. Gate should stop and reverse. If gate reverses then the control board is working correctly and the accessory is the problem. 5. If gate does not stop and reverse, the control board is the problem.
<p>11. Transmitter operating range seems short</p>	<ol style="list-style-type: none"> 1. Replace the batteries in the transmitter. 2. Verify that the receiver antenna (short wire connected to the receiver) is not twisted or rolled up. It should be pointing toward the control box cover. 3. Some type of radio frequency interference is obstructing signal from transmitter to receiver. Possible causes are electric fence, high voltage electric lines in ground or overhead. Radio towers in the area, military bases etc.. In some cases this might not be avoided or possibly a different frequency receiver needs to be installed.
<p>12. Gate 1 or 2 opens and closes, but stop positions have changed</p>	<ol style="list-style-type: none"> 1. Readjust retract or extend limits 2. Verify gate open or close speed is approximately 16 seconds 3. If much slower than 16 seconds, see problem 4.
<p>13. Gate 1 or Gate 2 only operates in one direction</p>	<ol style="list-style-type: none"> 1. Verify that the cable from linear actuator to control board has not been damaged. 2. If cable has splices, verify that connections are good and that any exposed wires are dry. 3. Verify that the problem exists in both the Gate 1 and gate 2 connectors on the control board. make sure dipswitch for Gate 1 or gate 2 is ON when testing. 4. If problem persists, call Sentry Customer Service. 1-866-711-0001.

Appendix

A The SENTRY Solar Charged System

The Sentry gate opener is the first truly solar charged gate opener for the Do It Yourself market. The system design and the accessories recommended are all Solar Friendly meaning that they require the least amount of energy possible to perform the job they were designed to do. The solar option allows you to install the gate opener in remote areas or in applications where you prefer to be solar charged. Solar charging provides isolation from lightning that might damage the unit via the AC power needed for the transformer.

The Sentry gate opener is designed to provide enough cycles a day for most installations without needing more than one solar panel. Care must be taken to ensure the solar panel has full sun throughout the day; partial sun will give partial results. If no sun is present then a solar system is not practical no matter how many panels might be installed. Solar Panel must be kept clean and in full sunlight.

The design of the system must pay particular attention to any accessories that might be added, use only Solar Friendly accessories to help avoid premature battery failure. For a complete list of accessories please visit www.sentrygateopener.com.

GATE CYCLES PER DAY SOLAR CHARGED SYSTEM (Optional Solar Kit PN #520015)

Solar charged systems should not exceed the cycles listed in the chart below. These numbers are based on a single 5 watt solar panel installation. If additional panels are installed additional cycles will be available.

Model Type	REGION 1	REGION 2	REGION 3
Sentry 300 S single gate	8 cycles per day	27 cycles per day	50 cycles per day
Sentry 300 D dual gate	5 cycles per day	13 cycles per day	23 cycles per day

Region 1 covers the area of the country receiving the least amount of solar radiation. On average the amount of charge time is 1.5 hours in region 1, 3 hours in region 2 and 5 hours in region 3.

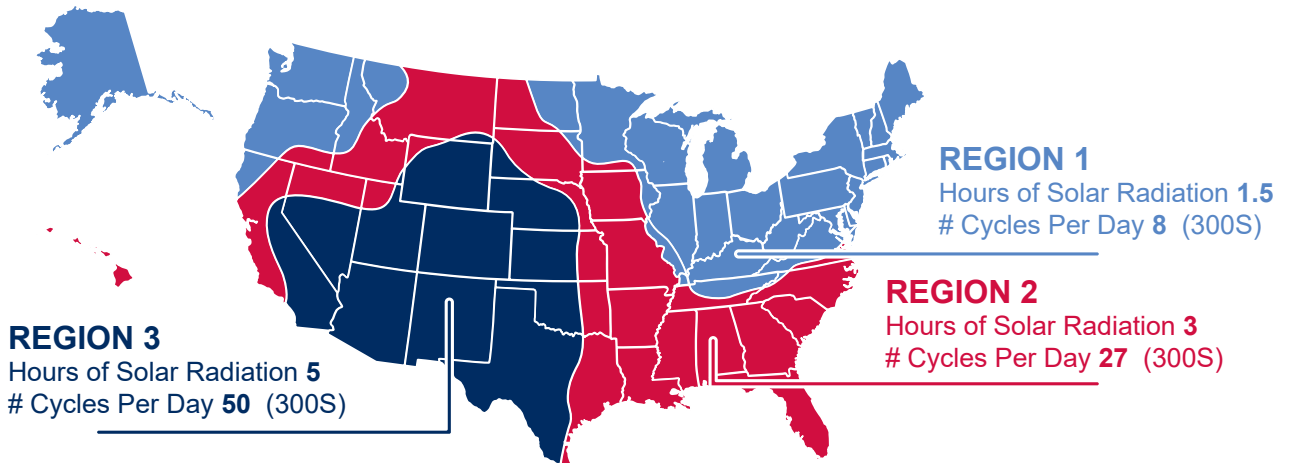

These are conservative numbers and the Sentry opener should have no problem performing as stated in the chart above. See Region Map above to determine cycles that can be expected. These numbers are based on a basic system and adding solar friendly accessories will not have any great affect on the numbers stated. Using other accessories can cause premature battery failure. Look for the solar friendly logo when considering accessories for your gate opener.



B Extending Charge Device Location (AC or Solar)

If charge device cable needs to be extended to reach the charge controller use “Sentry Charge Cable Extension Kit” Part Number 630050 (see figure). The kit contains junction box, DC plug pigtails and wire nuts. Use charts below to determine wire size needed for the distance to be extended. The cable must be a 2 conductor cable, stranded wire recommended.

Do not modify the transformer or solar panel cable, this will void the product warranty.

1. Splice mate for the charge controller to cable end located in control box.
2. Splice mate for the charge device to cable end that connects to charge device.
The junction box provided should be used to keep external connections dry.
3. Install DC plug connection and splice into junction box.



Sentry Charge Cable Extension Kit
Part Number 630050

Charge Cable Extension Cable Selection Chart

Transformer Extension Wire Size Chart				
0 to 100 ft	101 to 250 ft	251 to 500 ft	501 to 750 ft	750 to 1000 ft
18 gauge wire	16 gauge wire	14 gauge wire	12 gauge wire	10 gauge wire
Solar Extension Wire Size Chart				
	15 to 100 feet	100 to 250 feet	250 to 500 feet	
	16 gauge wire	14 gauge wire	12 gauge wire	

The wire used must be rated for Direct Burial use, unless in conduit. Wire ran in conduit must be rated for outdoor use. The above Table lists the recommended wire gauge per application length. Using a smaller gauge may impede performance or cause system to malfunction

C

CHARGE CONTROLLER

L.E.D. DESCRIPTIONS

EXTERNAL POWER ADAPTOR - Illuminates continuously while power from A.C. Power Supply Adaptor is sensed.

SOLAR PANEL - Illuminates continuously while power from Solar Panel is sensed.

DETECTION - If illuminated for longer than 3 seconds check connection on battery.

CHARGING - Continuous or flashing indicates charging.

CHARGED - On continuously when input power is present and battery fully charged. Flashes when battery capacity is low.

SYSTEM ERROR - If flashing, the charger has entered Failure Mode. Disconnecting power will reset charger, but if source of failure is not corrected, Failure Mode will occur again.- refer to the following Table to Decode the Error Type:

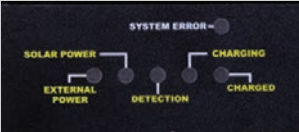
	L.E.D.s (First 4 L.E.D.s from Left)			
	1st	2nd	3rd	4th
Wrong Battery Voltage	Off	Off	Off	Flash
Reverse Battery Connection	Off	Off	Flash	Off
Thermal Runaway Condition	Off	Flash	Off	Off
Charge Time Monitor - 1	Off	Flash	Flash	Off
Charge Time Monitor - 2	Off	Flash	Flash	Flash
Excessive Battery Drain	Flash	Off	Off	Off
Failed Pre-Qualification Test -1	Flash	Off	Off	Flash
Failed Pre-Qualification Test -2	Flash	Off	Flash	Off

POSSIBLE REMEDIES TO CHARGE CONTROLLER 'FAILURES'

WRONG BATTERY VOLTAGE	Charger connected to a 24v battery. Reconnect to a battery rated at 12Vdc.
REVERSE BATTERY CONNECTION	Check and correct any reverse battery.
THERMAL RUNAWAY CONDITION	Old Battery - cells, inside battery, age differently. During charging, and over the course of many years of operation, OR, many battery discharges to levels beyond 100% discharged, this error may occur and the battery(s) may have to be replaced.
CHARGE TIME MONITOR – 1 and 2	<p>Battery pack took too long to complete its charge. Possible causes include a load (gate cycling repeatedly for a long period of time) during charging or the battery pack is too large (Many batteries connected in a parallel circuit). Apply the following formula to determine if the Timer may run out due to a large battery:</p> $\text{Charge Time} = \frac{\text{Battery Capacity (AH)}}{2} \times 1.25$ <p>Calculated Charge Time must be less than approximately 108hrs.</p> <p>Output Amps and Battery Capacity (AH - Ampere-hour) are listed on your battery or contact your battery purchasing source.</p> <p>Example: Charge time to for a fully discharged 36 AH battery: $36\text{AH} / 2 \text{ Amps} \times 1.25 = 22.5 \text{ Hrs} - \text{ok to use.}$</p>
EXCESSIVE BATTERY DRAIN	Excessively high number of cycles discharging the battery beyond point of no return. Stop gate, and allow battery time to recharge.
PRE-QUALIFICATION TEST - 1 and 2	During Battery testing, if a battery was previously allowed to discharge to a very low voltage, such as 1 or 2Vdc, the charger puts a low current through the battery to try to get the battery to come back to life. The battery may be taking too long to come back.
NO POWER ON CHARGER	Check the transformer Supply Adaptor Plug-in, or the Solar Panel for proper connection.

Sentry 300

WARRANTY AND REPAIR INFORMATION

If your Sentry Automatic Gate Opener is not operating properly, please follow all troubleshooting procedures in the Troubleshooting Guide in this Manual. If you are unable to solve the problem, call USAUTOMATIC at 1-866-711-0001, or visit our web site at www.sentrygateopener.com. We will help with troubleshooting and arrange repair or replacement, if needed. When you call, please have the model and serial number of the Sentry Automatic Gate Opener.

CONSUMER AFTER INSTALL: Return the enclosed warranty registration or register online at www.sentrygateopener.com. Retain your sales receipt for proof of purchase and date purchased.

3 YEAR WARRANTY

Warranty Coverage

If your Sentry Gate Opener, also referred to as the “Product”, does not work properly due to a defect in materials or workmanship, USAutomatic will, for the length of 3 years, which begins on the date of the original purchase, at its option either (a) repair your Product with new or refurbished parts, or (b) replace it with a new or refurbished Product. The repair or replacement of the Product will be made free of charge including parts, shop labor, and return to customer shipping and handling.

In all cases, the decision to repair or replace will be made by USAutomatic. Included shop labor does not apply to removal or installation of the Product on purchaser’s home or premises. Product must be shipped, at purchaser’s expense, to USAutomatic during the applicable Warranty period. The Warranty excludes both parts and labor for batteries, and cosmetic parts such as product housing and paint finishes. The Warranty only applies to Products purchased in the United States and is extended only to the original purchaser of a new product that was not sold “as is”.

Warranty Service

For assistance in the continental U.S.A. in obtaining the benefit of the Warranty please carefully follow these steps:

1. Complete carefully all troubleshooting procedures in the Troubleshooting Guide in this Manual.
2. If you are still unable to solve the problem, contact US Automatic customer service 1-866-711-0001. Please have the model and serial number of the Product available to give to the customer service representative. The customer service representative will provide further assistance or authorize repair or replacement, as appropriate.
3. If repair or replacement is appropriate, you will be given a return authorization number (RMA#). This RMA# must be visible on all documents and packages returned to US Automatic.
4. Carefully pack the defective Product or Product part in a sturdy shipping carton, include (1) a letter detailing the problem, (2) a daytime phone number where you can be reached, (3) your name and address for any return, (4) your sales receipt/proof of purchase, and (5) the RMA# on all correspondence and the shipping carton.
5. Prepay the freight and insure the defective Product or Product parts against shipping damage. Note that defective Products or Products parts shipped freight collect will not be accepted.
6. Ship the carton to US Automatic, LTD, 118 Hillside Drive, Lewisville, Texas 75057, or where directed by the customer service representative.

IF REPAIR OR REPLACEMENT IS NEEDED DURING THE WARRANTY PERIOD, THE PURCHASER WILL BE REQUIRED TO FURNISH A SALES RECEIPT/PROOF OF PURCHASE INDICATING DATE OF PURCHASE, AMOUNT PAID AND PLACE OF PURCHASE. THE PURCHASER WILL BE CHARGED FOR THE REPAIR OF ANY PRODUCT OR PRODUCT PART RECEIVED WITHOUT SUCH PROOF OF PURCHASE OR FOR REPAIRS REQUESTED OUTSIDE OF THE APPLICABLE WARRANTY PERIOD.

Warranty Limitations and Exclusions

This Limited Warranty ONLY COVERS failure due to defects in materials or workmanship, and DOES NOT COVER normal wear and tear or cosmetic damage, The Warranty ALSO DOES NOT COVER damages which occurred in shipment , or failures which are caused by products not supplied by USAutomatic, or failures which result from accidents, misuse, abuse, neglect, mishandling, misapplication, or alterations, faulty installation, connection to an improper power source, set-up adjustments, misadjustment of controls, improper maintenance, power line surges, damage from acts of God such as lightning, wind, fire, flood or insects, introduction of sand, humidity or liquids, commercial or rental use or service by anyone other than an Authorized Sentry Repair Center. THERE ARE NO EXPRESS WARRANTIES EXCEPT AS STATED UNDER “WARRANTY COVERAGE”. USAUTOMATIC IS NOT LIABLE FOR INCIDENTAL OR CONSEQUENTIAL DAMAGES RESULTING FROM THE USE OF THE PRODUCT, OR ARISING OUT OF ANY BREACH OF THIS LIMITED WARRANTY. (As examples, this excludes damages for lost time, lost calls or messages, cost of having someone remove or re-install Product or Product part, travel to and from an Authorized Sentry Repair Center, etc. The examples listed are not an exhaustive or exclusive list, but are illustration only). ALL EXPRESS AND IMPLIED WARRANTIES, INCLUDING ANY IMPLIED WARRANTIES OF MERCHANTABILITY OR FITNESS FOR A PARTICULAR PURPOSE, ARE LIMITED TO THE PERIOD OF THE WARRANTY.

Some States do not allow the exclusion or limitation of incidental or consequential damages, so the above limitation or exclusion may not apply to you. Some States do not allow limitations on how long an implied warranty lasts, so the above limitation may not apply to you. This warranty gives you specific legal rights, and you may also have other rights which vary from State to State.

PARTS AND SERVICES WHICH ARE NOT EXPRESSLY COVERED BY THIS WARRANTY ARE YOUR RESPONSIBILITY.

To register your Sentry 300 online:

www.sentrygateopener.com/Sentry_warranty.php

USAutomatic, LTD
118 Hillside Drive
Lewisville, Tx 75057
866-711-0001

Keep this information for your records

Model: _____ Serial Number*: _____

Date of Purchase: ____ / ____ / ____ Purchased from: _____

**Serial number can be found by opening cover and looking on the control board.*