

PATRIOT RSL

*High Quality Low Voltage
Vehicular Slide Gate Operator
Solar or AC Charged*

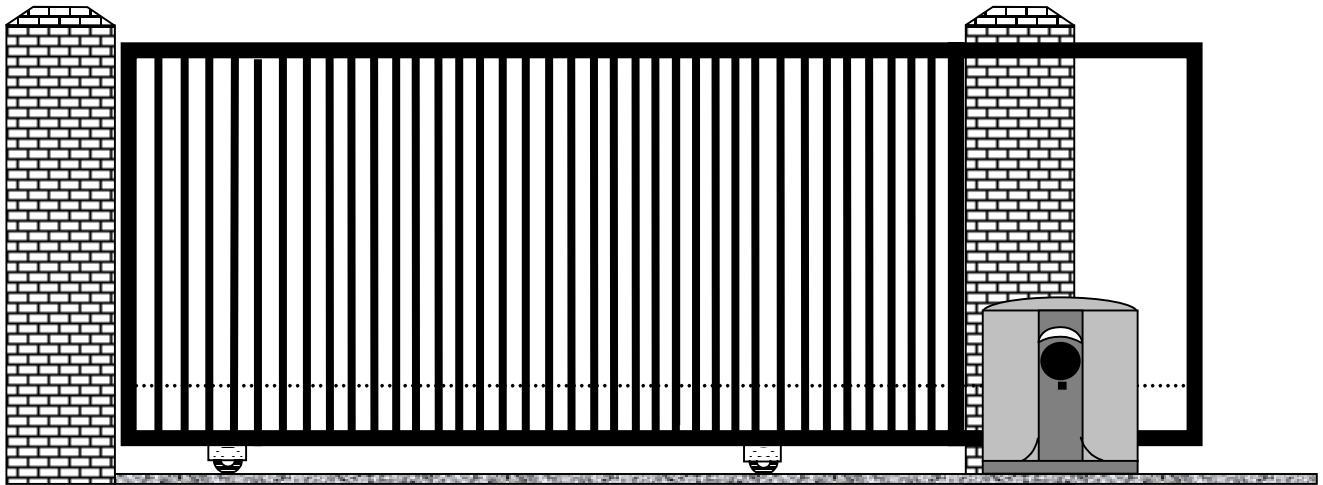

PATRIOT RSL Slide Gate Operator

Installation/Owners Manual



PROUDLY MADE IN THE USA



INTRODUCTION

This operator is intended to be installed on vehicular Class I or Class II gates as defined by UL 325. Maximum gate load not to exceed 600 pounds.

PLEASE READ THIS ENTIRE MANUAL CAREFULLY PRIOR TO INSTALLATION. In doing so, along with performance of the installation in step-by-step order, you will achieve optimal results. We strongly recommend that all installation and service personnel pay particularly close attention to the safety systems section of this manual and UL 325. In addition to the current sense feature that is provided, other safety devices are necessary to make each particular installation as safe as possible to reduce the risk of personal injury and/or property damage. A trained and authorized service technician or the factory should be consulted for assistance.

Cautions - Very Important

Do not attempt to enter the gate area while the gate is moving. Wait until the gate comes to a complete stop.

Operate the gate only when it is fully visible, free of persons or obstructions, and properly adjusted.

Do not allow children to play in the area of the gate. Do not allow anyone to ride on the gate.

Do not allow children to play with the remote control or any other activation device.

Do not attempt to "beat the gate" while the gate is opening or closing. This is extremely dangerous.

Test the current sense feature and all safety devices regularly to insure correct operation.

Study the entire Safety Section, paying particularly close attention to the Entrapment zones on page 17-21 and be aware of these areas not only during use but also during any adjustments to the unit.

Other Safety Standards

All control stations should be located at least 6 feet from any moving part of the gate or operator.

Do not ever install any control device where a user will be tempted to reach through the gate or fence to activate a gate.

© USAutomatic, Inc., 2001 rev N/C

All rights reserved. No part of this may be reproduced by any means without the expressed written consent of the publisher.

Table Of Contents

	<u>Page</u>
Introduction	1
Table of Contents	2
General Requirements/Gate Qualifications & Applications	3
Importance of a Properly Designed Gate.....	4
Mounting Site Review	4
Parts Included List	5
Operator Illustration/Description.....	6
Mounting Operator.....	7
Mounting Operator /Post Mount Installation.....	8
Pad Mount Installation.....	9
Mounting Chain Brackets/Connecting Chain.....	10
Installation of Charging Source	11
Installation of Secondary Entrapment Siren/Safety Placards	11
Final Adjustments	11,12
Current Sense Adjustment	12
Limit Switches/Installing Cover	13
Circuit Board & Terminal Description	14
Function of Programming Switch Settings.....	15-16
Emergency Manual Release.....	16
Safety Section	17-21
Troubleshooting Introduction	22
Troubleshooting Guide	23-25
Accessory Wiring Diagrams	26-30
Magnetic Wire Sensing Loops.....	31-32
Warranty Statement / Mail in Registration.....	Back Cover

GENERAL REQUIREMENTS

General hand/tools such as wrenches [7/16, 3/4], tape measure, level, clamps, chain cutter, etc. are required. Your particular installation may require a drill, welder or other hardware not provided. Concrete pad mounting by a qualified installer is the recommended method of securing the operator. Post mounting is also acceptable, additional support may be needed.

BATTERY REQUIRED FOR OPERATION (NOT INCLUDED).

We recommend a 12-volt deep cycle marine battery. The cable harness supplied with the operator is designed for bolt type adapters such as ones found on most marine batteries.

IMPORTANT CAUTIONS:

1. Do not test or operate this unit without first ensuring that all hardware is correctly installed, limit nuts are securely locked in place with the limit locking plate and all objects are clear of sprockets and chain.
2. Do not perform any welding with the control board or the battery connected. Serious damage to the control board and/or battery can occur if attempted.
3. Loose clothing can get caught in chain and sprockets resulting in bodily harm.

GATE QUALIFICATIONS/APPLICATIONS

GATE LENGTH/WEIGHT

This gate operator is rated for vehicular class I or class II slide gates up to 24 feet in length and up to 600 pounds in weight as defined by UL325. If your gate exceeds either one of these limits, please consult a qualified technician or the factory for alternative solutions.

Note: *High quality rollers with bearings will allow your gate to operate with minimal drag (minimal friction) and will decrease the load on the gate operator. Many type of slide gate designs exist. Choose a design that will decrease friction and required torque.*

GATE CYCLES PER DAY

Solar charged systems should not exceed 15 complete open/close cycles per day without additional solar panels. This gate operator, whether AC or Solar charged, should never be used in applications, which exceed 100 complete open/close cycles per day. Cycles can be decreased by holding the gate open during high cycle time periods. If more cycles are required, a high traffic gate opener should be used.

IMPORTANCE OF A PROPERLY DESIGNED GATE

As a general rule, a gate, which is to be automatically operated, must be stronger and smoother than one, which will be manually operated. Since the gate is a major component of the system, great care and concern must be given to the gate design.

A GATE OPERATOR CANNOT OVERCOME A POORLY DESIGNED GATE.

- A. Does the gate slide smoothly without binds or excessive resistance? Slide gates should slide level and plumb if possible to prevent the operator from having to pull the gate up or down grade when opening or closing. Low quality wheels and rollers usually create drag, which will cause operator problems. The use of high quality bearing wheels and rollers are highly recommended.
- B. Is the gate frame of substantial strength without excessive weight? Will the frame withstand normal wind load conditions without sway or vibration? Will the gate hit the catch correctly without being hand-guided or pushed into the catch?
- C. Are the bearings / wheels suited for the number of cycles expected per day?
- D. Is the track area designed to keep dirt and rocks from obstructing the gate movement?

If any of these problems exist, they must be corrected to achieve a reliable automatic gate system.

MOUNTING SITE REVIEW

Installers should ask themselves these questions prior to installation and predetermine the solution to any problems, which may occur.

- A. Does sufficient space exist for mounting and future servicing of the operator?
- B. *Will the unit open the gate by sliding to the left or the right? (see page 12 note #4)
- C. How will the chain brackets attach to the gate?
- D. How will the operator be mounted (on a pad or on a post)?
- E. How will the charging unit (AC or Solar) be brought to the control box?
- F. How and where will the solar panel mount if solar charged, so that optimum sunlight is received?
- G. How will control wiring, if any, be brought to the control box?
- H. Have all safety concerns been addressed? (See Safety Section Pgs. 17-21)

NOTE: *Standing on the operator side of the gate, an operator installed to the left of the drive is a left hand installation, an operator installed to the right is a right hand installation.

PARTS INCLUDED

The Patriot RSL slide gate operator is shipped in two separate boxes. One box contains the operator chassis and cover. The second box contains charging device (with bracket for solar), secondary entrapment siren, chain brackets, chain, transmitter, chain adjustment bolts, emergency release access cover and the installation/user manual with safety placards.

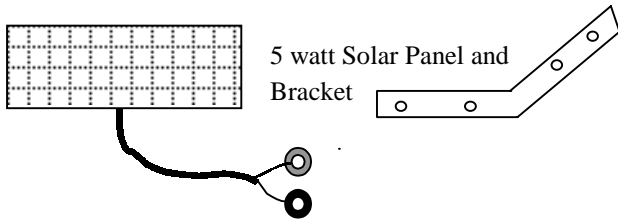

5 watt Solar Panel and Bracket

OR

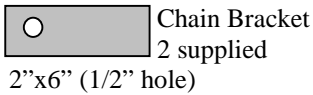
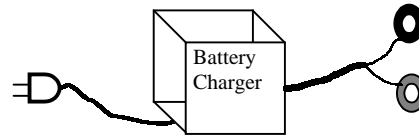

Chain Bracket
2 supplied
2"x6" (1/2" hole)



2- 1/2" x 6" Chain Adjustment Bolts
4- 1/2 inch Nuts



1 - Multi-code Transmitter

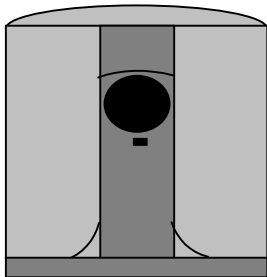
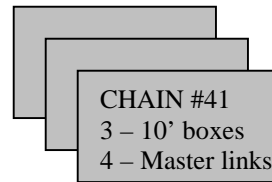

UV treated Polyethylene Cover

4 - 1/4" bolts

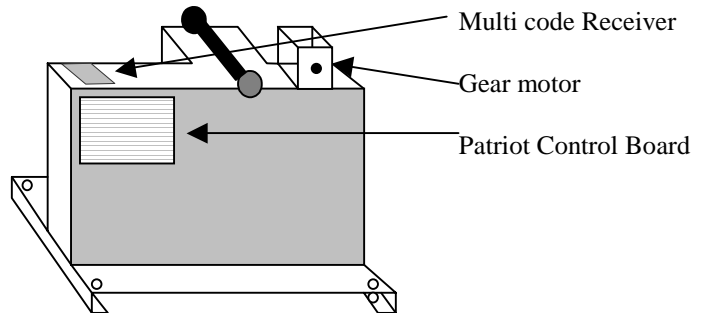

Operator Chassis



Safety Placards 2 supplied. Placards to be installed in plain view and on both sides of the gate.



Secondary Entrapment Siren +12vdc
2 push in snaps



Emergency release access cover

1 - cover, screw and nut

- **Placards (Two supplied) should be visible from inside and outside of gate.**

NOTE: 12 Volt DC deep cycle marine battery required. (Not Included)

Operator Illustration and Descriptions

TOP VIEW

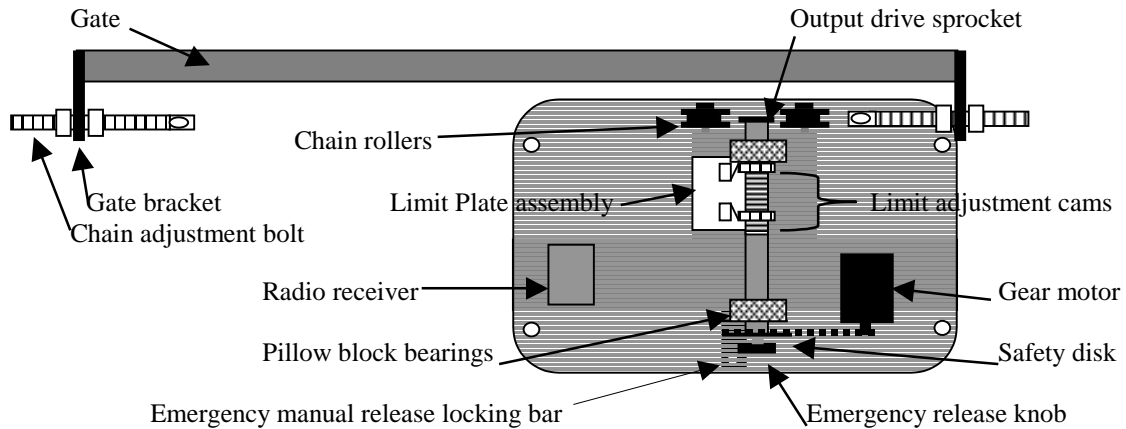

Illustration 1

FRONT VIEW

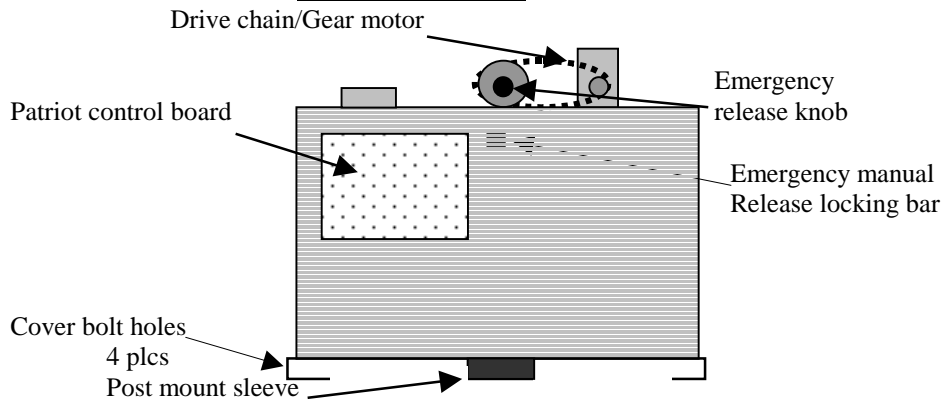

Illustration 2

REAR VIEW

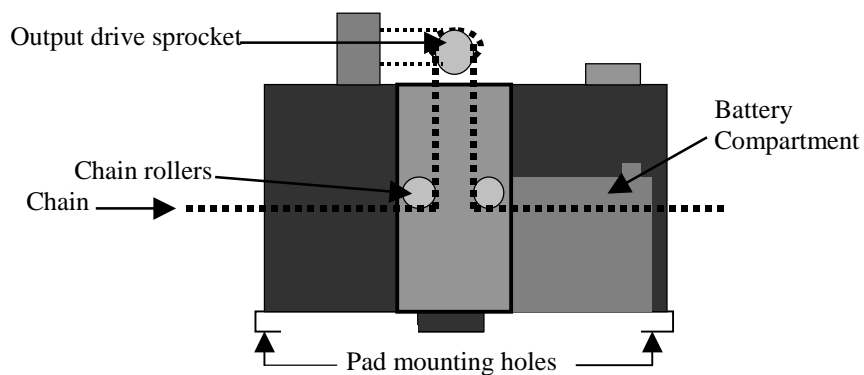
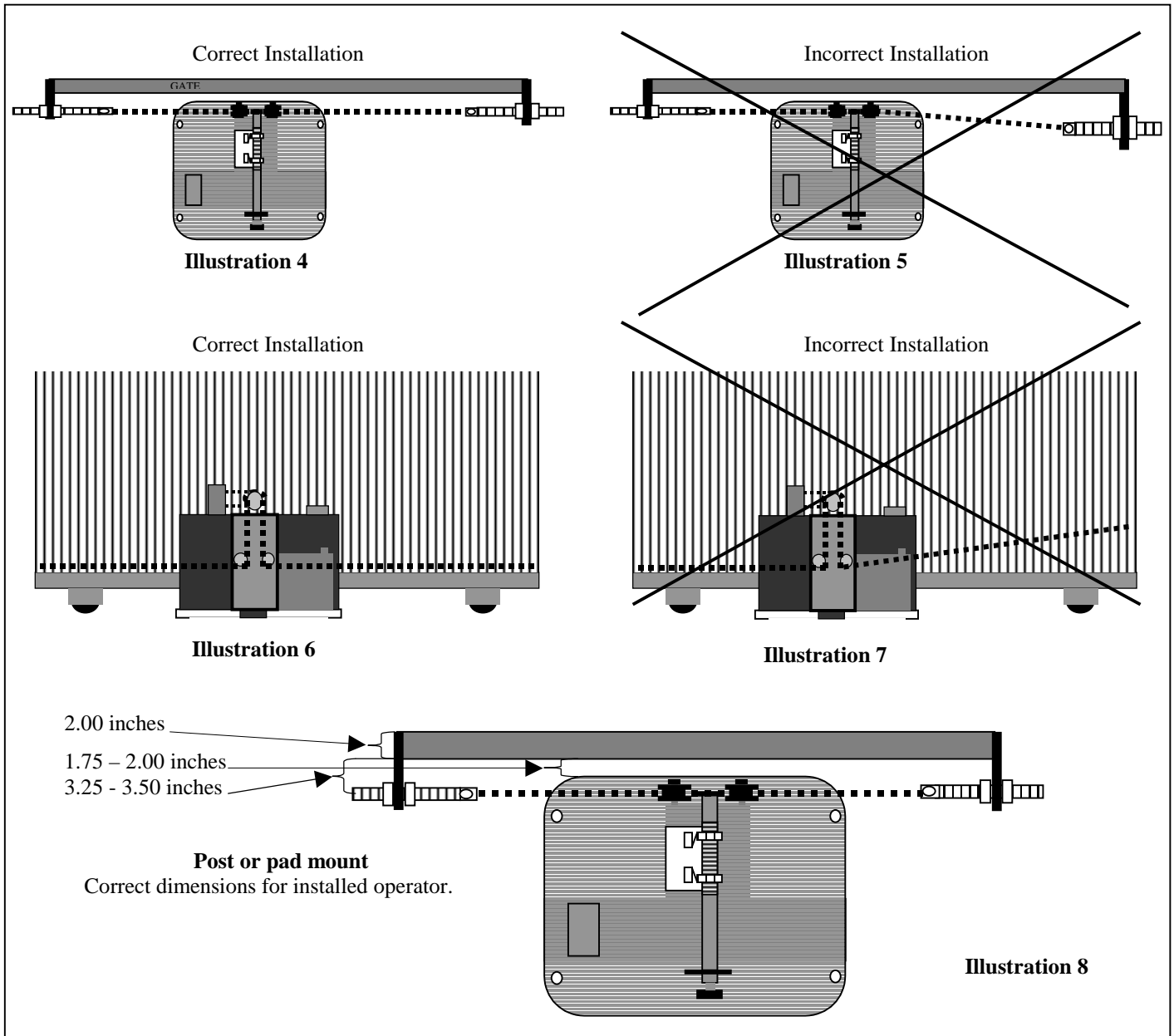

Illustration 3

Note: *USAutomatic is not responsible for failure to comply with UL325 standards, local building codes or improper installations.*

Mounting Operator

NOTE: Do not mount in areas by automatic sprinklers, or flood-prone areas. It is important that the control board, control devices, and the battery compartment remain dry.



Mounting Operator

PAD MOUNT:

The operator base has four predrilled holes and four access holes, which are covered with press in hole plugs. These holes are sized to accommodate 1/2 anchor bolts and the plugged hole will accept a standard size 3/4 inch socket. Keep the operator parallel with the gate while securing. See illustrations 9,13 and 14 for dimensions.

POST MOUNT:

The operator base is equipped with a four-inch post receiver located on the bottom of the base. This receiver will accept a square or round four-inch post. Keep the operator parallel with the gate and level while securing in place. See illustration 10 for dimensions.

Set the operator in place (pad or post). Ensure that the chain bolts once installed will be properly aligned with the chain rollers, see illustrations 4 – 8. Once alignment is verified secure operator in place using bolts for pad installation and welding for post installation. Keep the operator parallel with the gate while securing in place.

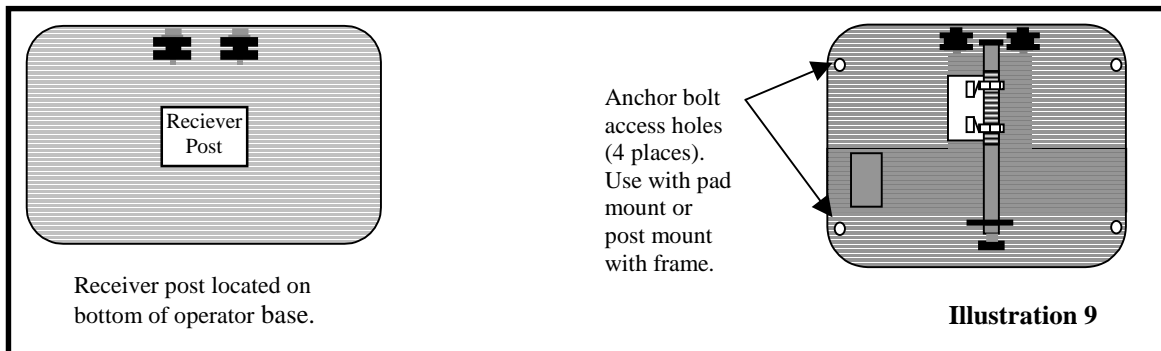

NOTE: Regardless of mounting method ensure that operator base does not extend into the driveway area, where damage from traffic could occur.

STEP 1 Post Mount Installation

POST SPECIFICATIONS

Steel post is an optional mounting method. The type of post the operator is designed to handle is a 4 inch round or square thick wall post. The operator can be installed directly onto the post or a steel frame can be constructed on the top of post. If the method chosen is to construct a frame see dimensions in pad mount section (Illustrations 13,14) for bolt locations and size. If the direct post mount option is chosen use the dimensions that follow to install, also consider that additional bracing might be needed.

POST LOCATION TO GATE EDGE AND HOLE PREPARATION

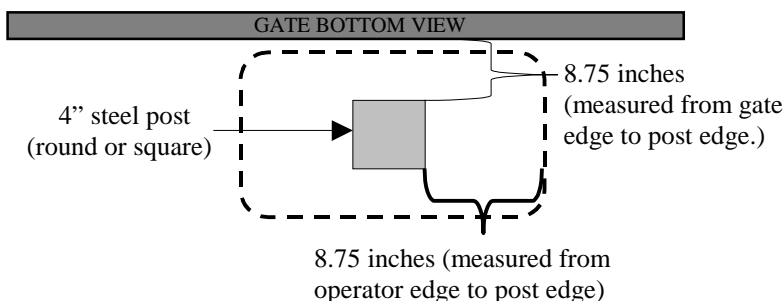

When determining post location ensure that the operator's outer edge is a safe distance away from the drive to avoid damage from traffic. See illustration 13 for operator base overall dimensions.

Illustration 10

Post must be parallel to gate edge. Hole depth should be at least 36 inches and bell shaped to reduce operator movement to a minimum. **The post must be concreted in place**

NOTE: Remember to mount the operator high enough above ground level so that the post and operator can be welded securely.

STEP 1 Pad Mount Installation

CONCRETE PAD CONSTRUCTION

The mounting foundation must be very stable and of sufficient strength to prevent any movement. Mounting site must be clear of flooding.

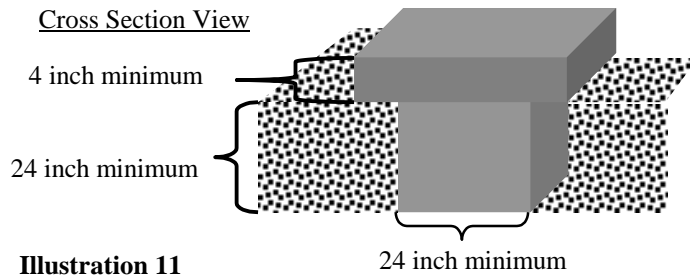

Illustration 11

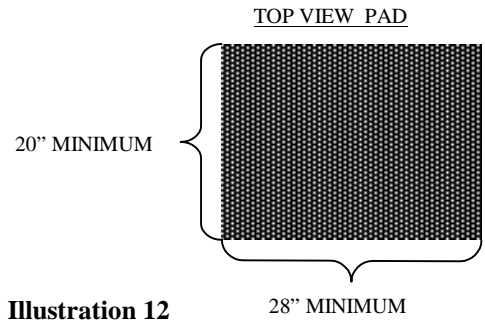
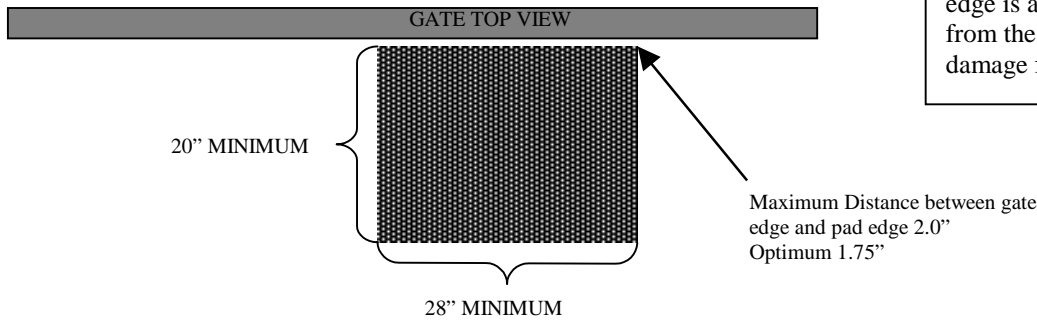

Illustration 12

Illustration shown is for dirt surface area. Surface areas of different material may require different pad dimensions.

CONCRETE PAD LOCATION TO GATE



When determining pad location ensure that the operator's outer edge is a safe distance away from the driveway to avoid damage from traffic.

Illustration 13

CONCRETE PAD ANCHOR BOLT LOCATION

Concrete pad top view measures 20" x 28". This allows for 4" of concrete between the anchor bolts and the outer edge of the pad. Use the drawing below to locate the four anchor bolts.

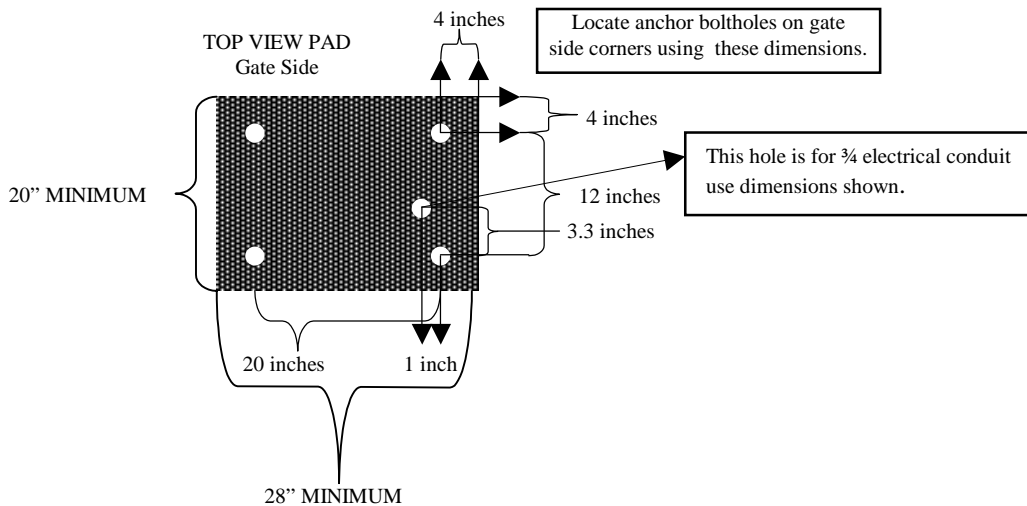

Illustration 14

Note: USAutomatic is not responsible for failure to comply with UL325 standards, local building codes or improper installations.

STEP 2 Mounting of Chain Brackets to Gate

With the operator securely mounted use the following procedure to locate and install gate brackets to gate ends.

1. Install the chain adjustment bolt into the chain bracket as shown in illustration 15 below.
2. Slide the gate fully open. Using the diagram below locate the correct position for the gate bracket. Clamp the bracket in place and repeat for gate in the fully closed position. Before welding gate brackets in place refer to illustrations 4 – 8 to ensure correct installation. Once alignment is correct weld chain brackets in place.

TOP VIEW (GATE FRAME 2")

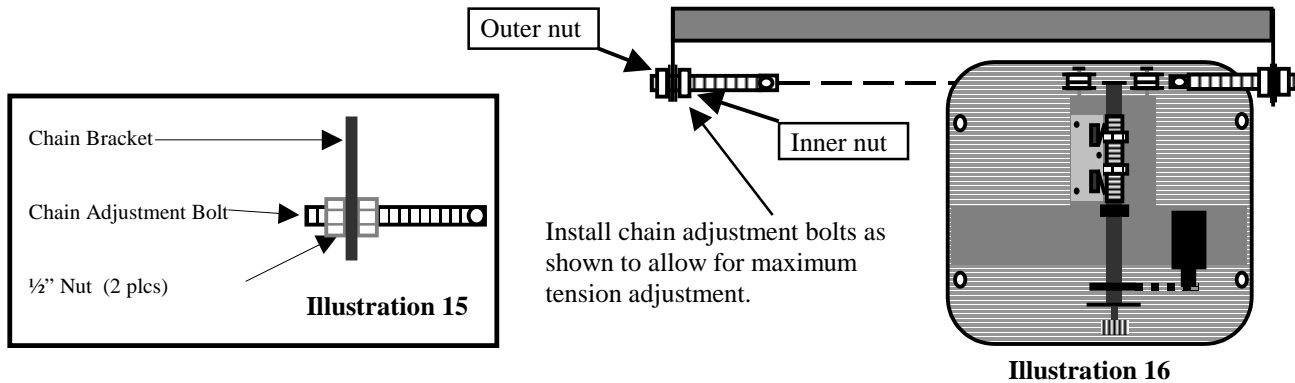

STEP 3 Connecting Chain

Using the master links supplied connect one end of chain to one of the chain adjustment bolts. Use additional master links to connect chain together as needed to route chain through the operator (See Illustration 3,16).

In most installations the chain will have to be cut to the desired length. To determine the desired chain length loosen the chain adjustment bolts to allow for maximum adjustment (illustration 15). Pull the emergency release knob to allow the chain to roll freely through the operator. Pull the chain to mate up with the remaining chain adjustment bolt and mark link that needs to be cut. Once link is cut install master link and connect to chain adjustment bolt.

CHAIN TENSION ADJUSTMENT

The outer 1/2 inch nut on the chain adjustment bolt adjust chain tension, it is important not to over tighten the chain or premature wear will result. It is also important not to allow the chain to be too loose. Once the chain tension is correct secure the inner 1/2 inch nut by tightening it against the chain bracket.

Once chain tension is correct and all nuts have been tightened push the emergency release knob back in place. It may be necessary to roll the gate while pushing in on the knob, once the alignment is correct the knob will slide in place.

STEP 4 Installation of Charging Source

SOLAR PANEL

Locate and mount the solar panel bracket so that the panel faces southwest and maintains the preformed 45-degree angle. The standard cable is 10' in length and must feed in through the bottom of the control box. Pay attention to the distance when determining you're mounting location. Although the cable can be extended with watertight connectors, charging power is diminished. Sometimes it is necessary to locate the panel farther away to achieve optimum sunlight, but consider that optimum sunlight might not mean optimum charging if the distance is too great. Use #16 gauge wire or larger and keep length as short as possible.

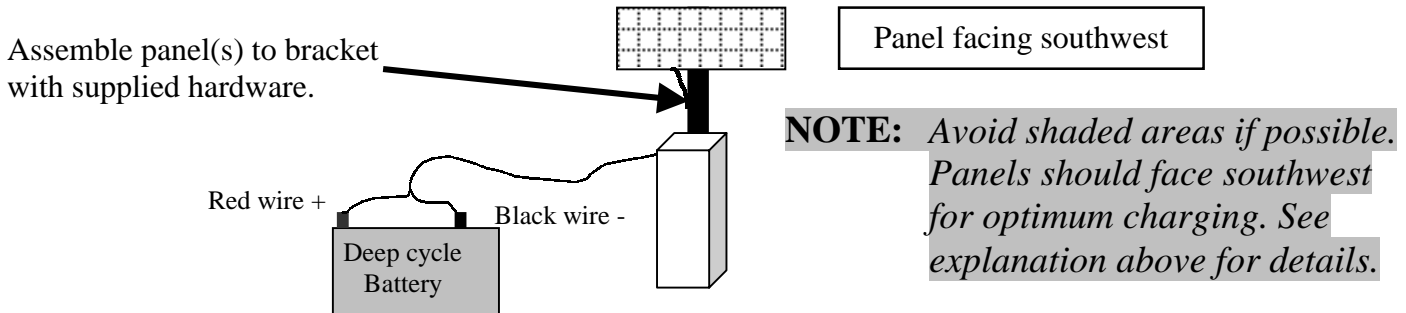

AC CHARGER

Locate and install the AC battery charger inside the operator chassis. A hole has been pre-punched for conduit in the base of the operator (Illustration 14 page 9). The charger requires a receptacle for 110-volt AC supply; recommended location is above the pre-punched hole. A licensed electrician per local building codes should install the receptacle.

Note: *USAutomatic recommends an AC surge protector on the 110-volt line especially in lightning prone areas.*

STEP 5 Installing Secondary Entrapment Siren

The secondary entrapment siren connects to the control board (see page 30). This siren is very loud and will be activated anytime the current sense circuit stops the gate twice prior to reaching a fully open or close limit. The reset button on the control board (see page 12) must be pushed to turn off the siren, and reset the control board. The frame has two pre-punched holes below the control board use these to secure the siren in place using the two snap in plastic fasteners.

STEP 6 Installing Safety Placards

Mount safety placards on gate. Two signs are provided. Place one sign on each side of the gate where it will be highly visible to anyone on either side of the gate.

STEP 7 Making Final Adjustments

In order to make final adjustments, a signal device such as a transmitter should be used. The gate will open if closed or close if in the open position. A signal in mid-travel will stop the gate. The next signal would reverse the gate from prior direction.

- If your unit was purchased with a radio receiver, it is important that you change the dipswitch code settings on your receiver and on all of your transmitters. Please read the instructions found with your transmitter or consult a dealer for assistance.

IMPORTANT NOTES

1. Locate the power plug and be aware that you may need to disconnect it from the circuit board if the gate over travels the desired stop points. You should be able to stop the motor with a signal from your transmitter, blue reset button or the push button command located on the control board without having to disconnect the plug, but in cases of incorrect wiring, the plug can be used as an emergency power shut-off.
2. Locate the sensitivity adjustment. We intentionally set the sensor at a highly sensitive setting. This may need to be adjusted to achieve gate movement without tripping the current sensitivity circuit and causing the gate to reverse direction. See current sense adjustment page 12 for details.
3. Study the limit switch section and instructions on adjusting the limit switches prior to battery hook up. See page 13 for details.
4. Left or right hand operation. The control board is shipped for right hand installation, if left hand operation is desired the dipswitch (DS1) number 9 located on the control board upper left corner must be turned on. This will eliminate the need to rewire the operator and allow all auto close functions and accessories to operate correctly. See note at the bottom of page 4.

If you have an understanding of the current sense feature, how to disconnect the power plug in an emergency, and how to adjust the limit switches, then proceed to hook up the battery leads and connect the plug to the board. The red battery lead goes to the positive + terminal on the battery and the black lead goes to the negative - terminal on the battery.

Current Sense Adjust

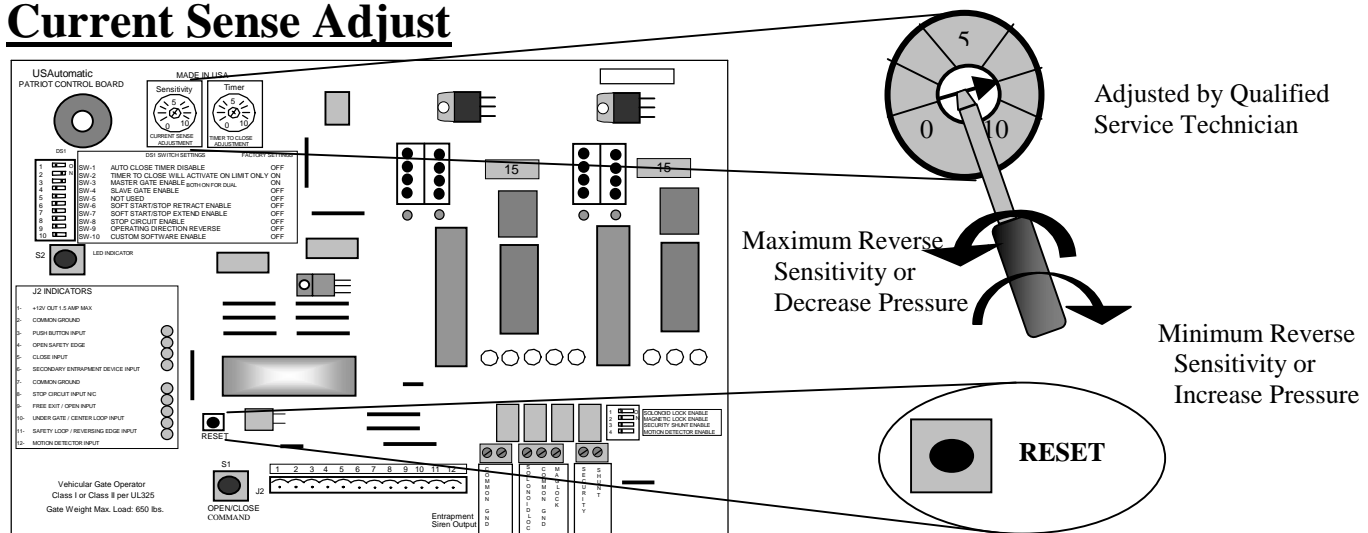

The Patriot circuit board is equipped with a piezo buzzer, which will beep whenever the current sensing circuit is triggered. There is a time delay between the beep and when the current sense circuit actually stops the gate, this delay allows the effects of wind and other none fixed objects not to falsely stop the gate. The recommended adjustment for a sliding gate would be to hear the beep on startup only. If a less sensitive installation is required adjust the current sensor up. Do not turn the dial beyond the stop points at 0 and 10.

NOTE: *If current sensor is activated twice before reaching an open or closed limit switch position the operator will stop operating and require a manual reset using the reset button on the control board.*

- Remember if the gate reverses direction twice before reaching a limit switch the reset button on the control board must be reset. If no obstructions were present then minimizing sensitivity (increasing pressure) may be required. Do not minimize sensitivity any more than necessary.

LIMIT SWITCHES

The limit switch adjustments are located on the top shelf of the operator. Remove the cover from the operator to make adjustments. The normal settings from the factory allow for about 15 feet of travel. You will most likely have to adjust the limits for your installation. To adjust limits press down on the limit plate assembly, this will release the limit plate from the limit adjustment cams and allow the cams to turn. Turn the limit adjustment cam, which corresponds to the direction you want to adjust.

NOTE: *WHEN THE LIMIT ADJUSTMENT CAM DEPRESSES THE LIMIT SWITCH ACTUATOR THE GATE WILL STOP.*

Top view of the operator

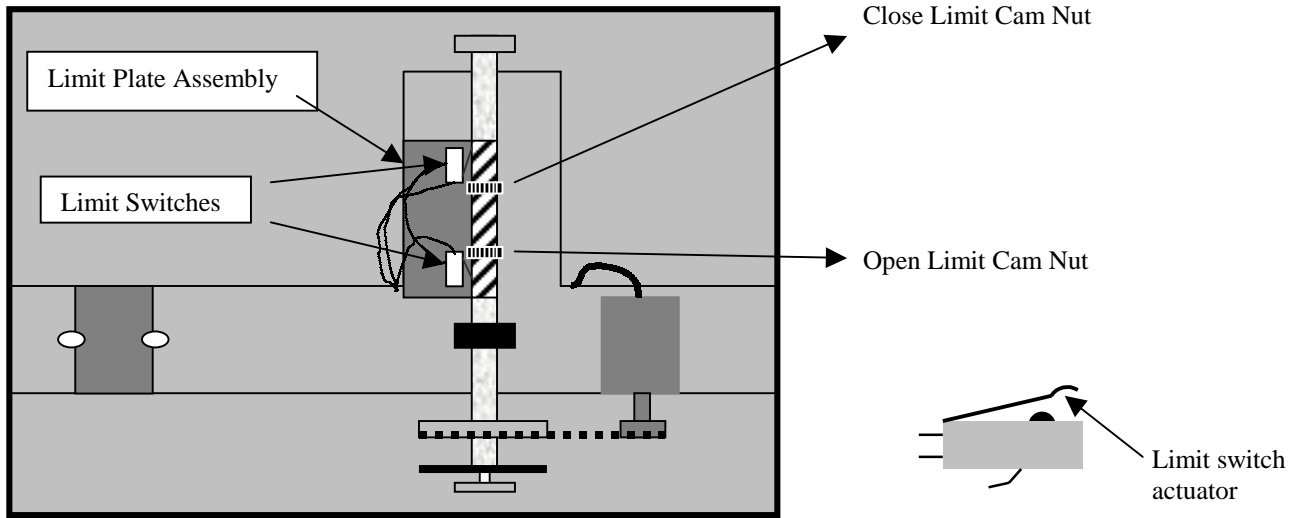

NOTE: *DO NOT ADJUST THE LIMIT CAM NUTS PAST THE LIMIT SWITCH ACTUATOR ARM. THIS MAY RESULT IN DAMAGE TO THE LIMIT SWITCH. ENSURE THE LIMIT PLATE ASSEMBLY SNAPS INTO THE GROOVES ON THE LIMIT ADJUSTMENT CAMS PRIOR TO OPERATION.*

CAUTION: To reduce the risk of injury, USAutomatic strongly recommends the installation of additional safety devices such as Photo Eye Sensors and Safety Edges. Consult an authorized installing dealer or the factory for a complete explanation of options and see the Safety Section of this manual on pages 17 to 21.

STEP 8 Installing Cover

Locate the emergency release access cover (round cover with USAutomatic logo), the shoulder screw and nut. Install screw through emergency release access cover and install onto operator cover using the supplied nut. Tighten nut securely.

Place the cover over the operator with the emergency release knob visible through the access hole. Secure in place using the 4 – 1/4” bolts and flat washers supplied. Slide the locking bar through slot cut below access hole and secure to emergency manual release access cover, using a lock.

NOTE: *USAutomatic strongly recommends the Emergency manual release access cover be securely locked in place using the locking bar and pad lock (pad lock not supplied)*

Circuit Board & Terminal Description

Patriot Control Board

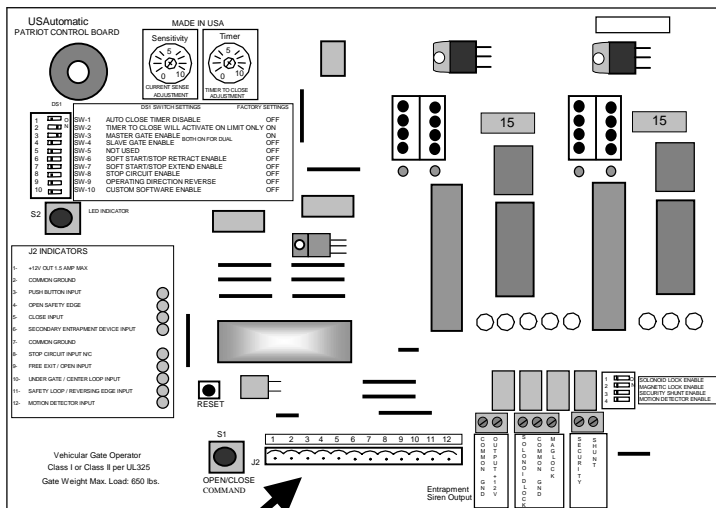

TERMINAL DESCRIPTION

- 1 + 12 volt DC Output.**
*Maximum current output 1.5 amp (1500 milliamps)
- 2 Common Ground Input**
- 3 Push Button Input.** (normally open contacts)
Push button, radio control, keypad, etc.
- 4 Open Safety Edge** (normally open contacts)
(Stops gate while opening)
- 5 Close Input** (normally open contacts)
- 6 Secondary Entrapment Input** (normally open contacts)
- 7 Common Ground Input**
- 8 Stop Circuit Input** (normally closed contacts)
* DS1 switch #8 must be on for stop circuit function to be enabled.
- 9 Free Exit/Open Input** (normally open contacts)
Loop input or any hold open input such as a 7-day timer, telephone access unit, or maintain contact switch (normally open contacts). These devices open the gate and will prevent the gate from closing if the contact is maintained. Once the contacts have been released, the gate can be closed with a closing signal device or the automatic close timer feature.
- 10 Center Loop or Under Gate Loop Input** (normally open contacts)
- 11 Safety Loop/Reversing Edge Input** (normally open contacts)
- 12 Motion Detector Input** (normally open contacts)
(Stops a closed gate from opening)(Active on close limit only)

DS1 Programming Switches

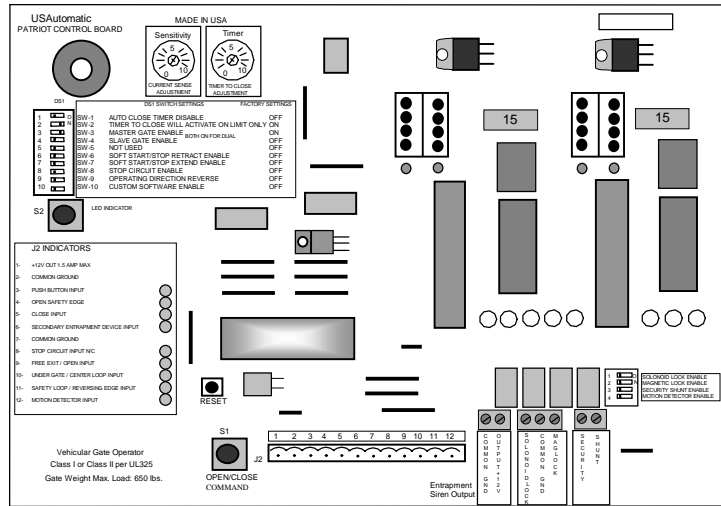

Factory settings are shown in bold italic type

- 1 Automatic close timer circuit enable
 ON Timer to close is activated
 OFF ***Timer to close is disabled***
- 2 Open limit timer to close function
 ON ***Timer to close activates only if open limit is activated***
 OFF Timer to close works from any point the gate is stopped
- 3 Master Gate Enable
 ON ***Master gate operator enabled to function***
 OFF Master gate operator disabled
- 4 Slave Gate Enabled (Both Master and Slave on for dual)
 ON Slave gate operator enabled to function
 OFF ***Slave gate operator disabled***
- 5 Not Used at this time
 ON ***No function***
 OFF ***No function***
- 6 Soft Start / Soft Retract Enable
 ON Enables soft start/stop for Retract position
 OFF ***Disables soft start/stop***
- 7 Soft Start / Soft Extend Enable
 ON Enables soft start/stop for extend position
 OFF ***Disables soft start/stop***
- 8 Stop circuit enable
 ON Allows for a stop button input to be utilized
 * a normally closed pushbutton is required
 OFF ***Disables the stop button function***
- 9 Operating Direction Reverse
 ON Push to Open or Left Hand Slider installation (See note bottom page 4)
 OFF ***Pull to Open or Right Hand Slider Installation***
- 10 Custom Software Enable
 ON Enables Custom software if applicable
 OFF ***Disables Custom Software***

NOTE: Soft start and stop are not to be used on Slide gate operators. Doing so will damage the control board.

DS2 Programming Switches

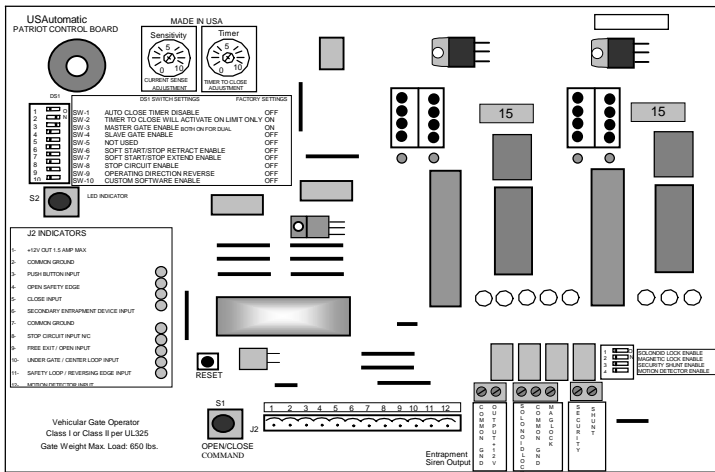

Factory settings are shown in bold italic type

- 1 Solenoid lock enable / Gate in operation indicator
ON Solenoid lock output energizes half second before gate begins to move and remains energized until four seconds after reaching a limit (+12Vdc output 1.5 amp max)
OFF *Solenoid lock / gate in operation indicator is inactive*
- 2 Magnetic lock enable
ON Magnetic lock relay is active and will release half second before gate begins to open (+12 vdc output 1.5 amp max)
OFF *Magnetic lock relay is inactive*
- 3 Security Shunt Circuit Enable / Open Gate Indicator
ON Security shunt circuit relay is active (closed circuit)(wire in parallel)
OFF *Security shunt circuit relay is inactive (open circuit)*
- 4 Motion Detector Enable
ON Activates motion detector input (if input is activated gate will not open)
OFF *Disables motion detector input*

Emergency Manual Release

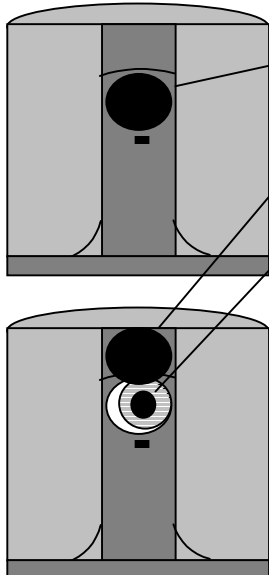

Emergency manual release cover
 Remove lock and rotate emergency manual release cover to the up position.

Pull manual release knob out (about ¾ inch)
 Once knob has been pulled the gate can then be pushed by hand.
 If knob cannot be pulled the gate may need to be agitated left or right.

To reset the knob push in on knob and roll gate until knob snaps in place.

WARNING: *Only insert hand into access hole as far as needed to grip the release knob.*

Trying to insert hand farther can result in injury.

SAFETY SECTION

USAutomatic gate operators are certified to UL325 Vehicular Class I and Class II slide gate standards.

UL325 identifies four different classes of gate operators. These classes are listed below:

- Class I:** Residential vehicular gate operator- a vehicular gate operator (or system) intended for use in a home of one to four single family dwellings or a garage or parking area associated therewith.
- Class II:** Commercial/General access vehicular gate operator- a vehicular gate operator (or system) intended for use in a commercial location or building such as multi-family housing unit (five or more single family units), hotel garages, retail store, or other buildings servicing the general public.
- Class III:** Industrial/Limited access vehicular gate operator- a vehicular gate operator (or system) intended for use in an industrial location or building such as a factory or loading dock area or other locations not intended to serve the general public.
- Class IV:** Restricted Access vehicular gate operator- a vehicular gate operator (or system) intended for use in a guarded industrial location or building such as an airport security area or other restricted access locations not servicing the general public, in which unauthorized access is prevented via supervision by security personnel.

The Patriot slide gate operator is designed and intended for use on Class I or Class II vehicular gate installations. The maximum load of each gate leaf should not exceed 600 pounds with a length not to exceed twenty-four feet.

SECONDARY ENTRAPMENT DEVICES

USAutomatic has designed all control boards with secondary entrapment device inputs and secondary safety devices must be installed with all installations. USAutomatic recommends the use of the following devices and has provided herein instructions for the connection of such devices.

NOTE: *USAutomatic recommends that these devices be CONNECTED after proper gate installation and operation has been verified. Then connect one device and verify proper operation before installing the next device. Ensure that power is disconnected from the control board prior to connecting any wires to the control board.*

Contact Safety Devices: Safety Edges

Manufacturer - Miller Edge

<u>Model</u>	<u>Description</u>
MGR20	3 sided protection fitted for 2" round frame
MGS20	3 sided protection fitted for 2" square frame
ME120	1-sided protection attaches to flat surface
MG020	1-sided protection attaches to flat surface
ME123	1-sided protection attaches to flat surface

Non-Contact Safety Device: Photo Eyes

Manufacturer – EMX Industries INC.

<u>Model</u>	<u>Description</u>
IRB-325	+12vdc Photo Eye

Manufacturer – Allen-Bradley

<u>Model</u>	<u>Description</u>
42GRU-9001	+12vdc Photo Eye

Entrapment Alarm Devices: Sirens

Manufacturer – USAutomatic

<u>Model</u>	<u>Description</u>
W12b-3	Piezoelectric siren, 108db +12vdc

NOTE: *For information about installation or applications, consult factory*

SAFETY SECTION

INSTALLATION

- a) Install the gate operator only when:
 - 1) The operator is appropriate for the construction of the gate and the usage class of the gate,
 - 2) All openings of a horizontal slide gate are guarded or screened from the bottom of the gate to a minimum of 4 feet (1.2m) above the ground to prevent a 2 ¼ inch (57.15mm) diameter sphere from passing through the openings anywhere in the gate, and in that portion of the adjacent fence that the gate covers in the open position,
 - 3) All exposed pinch points are eliminated or guarded, and
 - 4) Guarding is supplied for exposed rollers.
- b) Only install on vehicular gates, pedestrians must be supplied with a separate access opening.
- c) The gate is installed in a location where enough space is supplied between adjacent structures and the gate so that when opening or closing the chance of entrapment is reduced.
- d) The gate must be properly installed and work freely in both directions prior to the installation of the gate operator. Do not minimize the sensitivity adjustment to compensate for an improper gate installation.
- e) Locate all controls at least six feet away from the gate to eliminate the chance of the person operating the gate from coming in contact with the moving gate. Do not install external buttons, which can be used to operate the gate within the reach of children.
- f) All placards must be installed one on each side of the gate and be visible in the gate area.
- g) For gate operators utilizing a non-contact sensor:
 - 1) See instructions on the placement of non-contact sensors for each type of application,
 - 2) Care shall be exercised to reduce the risk of nuisance tripping, such as when a vehicle, trips the sensor while the gate is moving, and
 - 3) One or more non-contact sensors shall be located where the risk of entrapment or obstruction exist, such as the perimeter reachable by a moving gate or barrier.
- h) For gate operators utilizing a contact sensor:
 - 1) One or more contact sensors shall be located at the leading edge, trailing edge, and post mounted both inside and outside of a vehicular horizontal slide gate.
 - 2) A hardwired contact sensor shall be located and it's wiring arranged so that the communication between the sensor and the gate operator is not subjected to mechanical damage.
 - 3) A wireless contact sensor such as one that transmits radio frequency (RF) signals to the gate operator for entrapment protection functions shall be located where the transmission of the signals are not obstructed or impeded by building structures, natural landscaping or similar obstruction. A wireless contact sensor shall function under the intended end-use conditions.

WARNING: TO REDUCE THE RISK OF INJURY OR DEATH

1. **READ AND FOLLOW ALL INSTRUCTIONS**
2. **Never let children operate or play with gate controls. Keep remote control away from children.**
3. **Always keep people and objects away from the gate. NO ONE SHOULD CROSS THE PATH OF A MOVING GATE.**
4. **Test gate operator monthly. The gate must stop and reverse directions upon contacting a rigid object or when the secondary entrapment device is activated.**
5. **After all adjustments have been made to the limit switches, sensitivity (current sense) circuit, secondary entrapment devices and all other external devices installed the safety devices must be checked again. Failure to adjust and retest the gate operator can increase the risk of injury or death.**
6. **Verify that the emergency release (manual release) knob can be pulled easily. This should only be checked when power is disconnected from the operator.**
7. **KEEP GATES PROPERLY MAINTAINED. Read the user manual and have a qualified service technician make repairs to the gate hardware.**
8. **THE ENTRANCE IS TO BE USED BY VEHICLES ONLY. Pedestrians must use a separate entrance.**
9. **SAVE THESE INSTRUCTIONS**

SAFETY SECTION

All safety features required by UL 325 are incorporated in the capabilities of all USAutomatic Control boards and should be utilized, including but not limited to, safety edges, photo electric eyes, reverse sensing, and motion sensing.

Cautions - Very Important

- Do not attempt to enter the gate area while the gate is moving. Wait until the gate comes to a complete stop.
- Operate the gate only when it is fully visible, free of persons or obstructions, and properly adjusted.
- Do not allow children to play in the area of the gate. Do not allow anyone to ride on the gate.
- Do not allow children to play with the remote control or any other activation device. Do not attempt to "beat the gate" while the gate is opening or closing. This is extremely dangerous.
- Test the current sense feature and all safety devices regularly to insure correct operation.
- Study this entire Safety Section paying particularly close attention to the entrapment zones shown below and be aware of these areas not on during use but also during any adjustments to the unit.

ENTRAPMENT ZONES

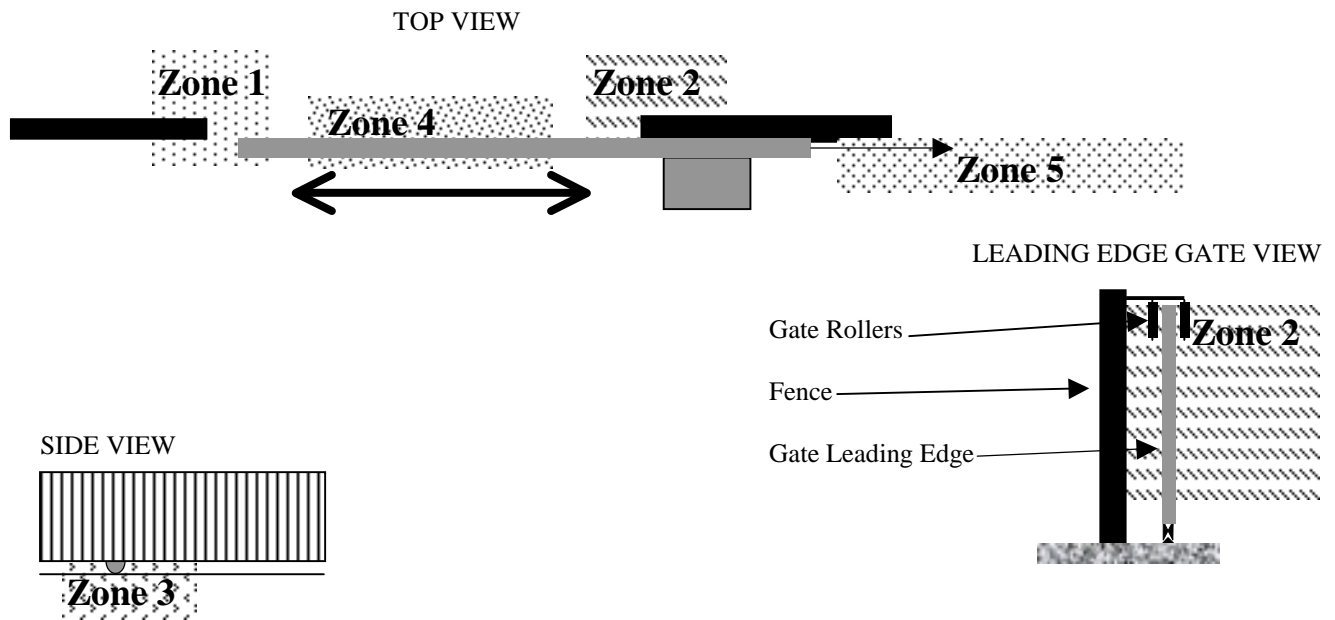

- Zone 1 The leading edge of the gate & fence post.
- Zone 2 Between the gate and fence pocket.
- Zone 3 The gate track and wheel.
- Zone 4 The path the gate travels across the drive. (traffic area)
- Zone 5 The path the gate travels when opening (back track gate area)

SAFETY SECTION

Remedies for Safety Concerns

Zone 1 Safety edges and photo electric eyes are the most common types of protection available.

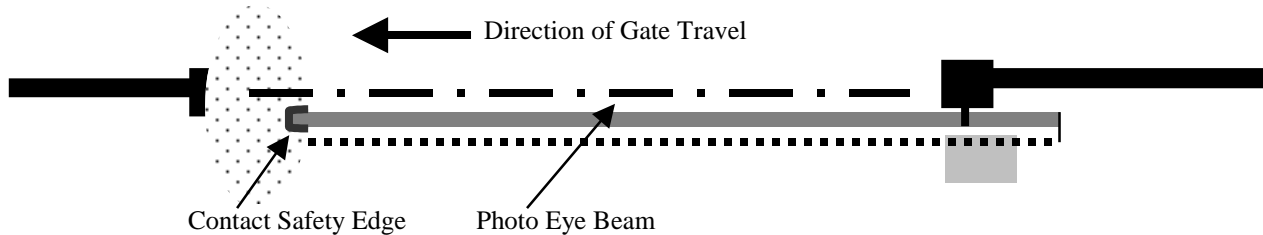

Zone 2 A safety edge may also be utilized here but the best remedy is to eliminate pinch points when designing the gate. Most injuries at this point result from negligence, such as reaching through the gate to activate a button, key switch, etc., or riding the gate open.

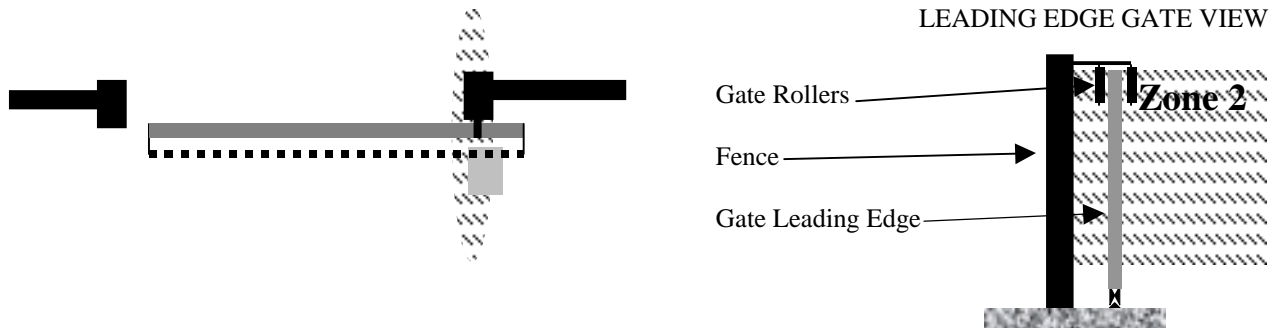

Zone 3 This area is best protected with proper gate construction and installation. Care must be taken to minimize the exposed wheel to track area. A photo-eye or contact edge might also work in this area depending on your gate construction.

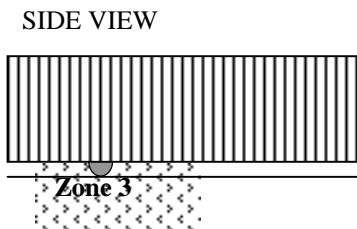

See page 18 under installation a. 3 and 4 for more information.

NOTE: All control stations should be located at least 6 feet from any moving part of the gate or operator.

Never install any control device where a user will be tempted to reach through the gate or fence to activate a gate.

SAFETY SECTION

Remedies for Safety Concerns

Zone 4 This area is best protected with a photo eye or contact edge wired to the secondary entrapment input or safety loop input depending on the desired function of the safety device. The beam should be installed parallel to the gate and extend across the drive area to prevent the gate from closing or opening on an object in the path of the gate. If the intent of the beam is to prevent the gate from closing when an object is present wire the photo eye to safety loop input on the control board.

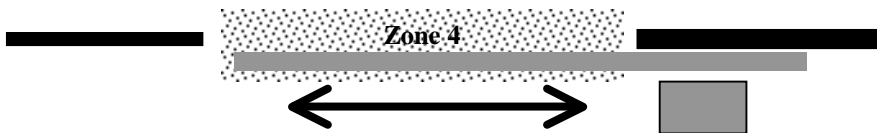

Zone 5 Safety edges and photo eyes are the most common types of protection available. The safety device used should be wired to the secondary entrapment input.

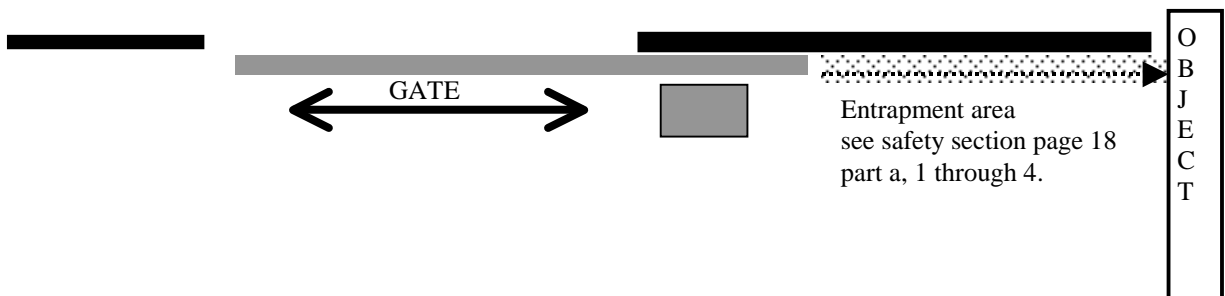

Every installation is unique and it is the installer's responsibility to recognize and remedy all safety concerns. Please consult a qualified dealer or the factory for a complete explanation of the remedies shown above and additional tips pertaining to your installation.

SERVICE

All gate operators require periodic checking and adjustments by a qualified technician of the control mechanism for force (load), speed and sensitivity. All external accessories and secondary safety devices must be checked. Secondary safety devices need to be checked at least once a month for proper operation.

Periodic checking is also advised for the following:

1. Battery cells water level. (use distilled water if needed)
2. Wheels and gate rollers for wear and grease if necessary.
3. Bolts for correct tightness.
4. Inspect weld points for cracks or other defects.
5. Inspect wiring for cuts, nicks or other defects.
6. Inspect drive chain and sprockets for tension and wear. Adjust or replace as necessary.
7. Time to open or close the gate, this will be first indication of a battery or charging problem.

Troubleshooting Introduction

The USAutomatic control board is equipped with three unique features to assist in troubleshooting a gate system.

1. The first and most helpful is the series of LED indicating lights. These lights will help to identify problems with the limit switches and all control circuits. To use the indicators, press and hold the LED indicator button on the control board. (The lights are not active at all times to save battery life). Any circuits or limit switches that are activated will be identified by the illumination of the adjacent LED indicating light.
2. The second feature to assist in troubleshooting is the current sense beeper. The beeper will sound anytime the current sense circuit is activated. This is useful in detecting a false reverse due to an improper or too sensitive current reverse setting or a gate that is requiring excessive force to move.
3. The third feature to assist in troubleshooting is the on board open/close command pushbutton. This button makes it possible to operate the gate with the twelve terminal wiring plug removed without having to short across terminal pins.

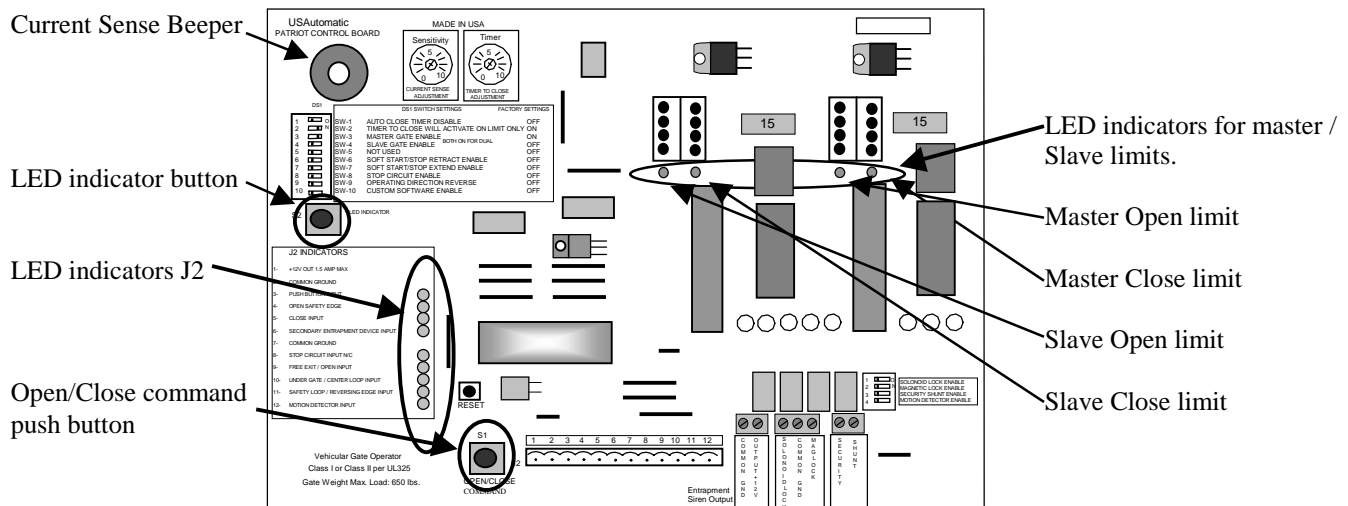

TROUBLESHOOTING GUIDE

<i>SYMPTOM</i>	<i>POSSIBLE CAUSE</i>	<i>REMEDY</i>
<p>1. Gate stops and reverses direction in mid-travel.</p> <p>*If this happens twice before engaging either limit switch the operator will shut down and need to be reset.</p>	<p>a. Current sense feature may be set too sensitive. Listen for on board beeper to verify. Beep indicates current sense circuit activated.</p> <p>b. Gate operator is not plumb & level.</p> <p>c. Gate or rollers are binding or are not plumb and level.</p> <p>d. Control board is defective.</p>	<p>Readjust- see page 12.</p> <p>CAUTION: Sensitivity should be sensitive enough to avoid injury.</p> <p>Remount operator or chain brackets. See page 9.</p> <p>Repair gate and readjust limits and board settings.</p> <p>Replace control board.</p>
<p>2. Gate travels OK but after fully opening or closing reverses direction.</p>	<p>a. Too much travel distance on opening or closing cycle. Causing current sense to activate.</p> <p>b. Wiring harness damaged or loose</p> <p>c. Control board is defective.</p> <p>d. Free exit false activating.</p>	<p>Readjust appropriate limit switch See page 13.</p> <p>Check actuator plug at control board and cable for nicks or tears.</p> <p>Replace control board.</p> <p>Depress LED push button and hold, watch Led lights to determine which input is activating, correct as necessary.</p>
<p>3. Gate doesn't move at all.</p>	<p>a. Current sense circuit activated twice prior to reaching fully open or close position.</p> <p>b. DS1 switch settings</p> <p>c. Blown fuse</p> <p>d. Limit switches misadjusted (if open and close limit lights are on at the same time control board will not operate).</p> <p>e. Loose or incorrect battery connections or voltage.</p> <p>f. Wiring harness damaged or has loose connection.</p> <p>g. Control board is defective.</p> <p>h. A control device such as a push-button, remote control, keyswitch, etc. is shorted, which will lock up the circuit board.</p>	<p>Reset control board using reset button on control board.</p> <p>Verify switch 3 or 4 is on. (Both 3 & 4 for a dual gate)</p> <p>Replace if blown with 15-amp max.</p> <p>Depress S2 and verify correct limit lights are on (D1,D2,D3,D4) readjust if necessary</p> <p>Check battery connections, polarity and voltage/at least 12.5 vdc.</p> <p>Check actuator plug at control board and cable for nicks or tears.</p> <p>Replace control board.</p> <p>Depress LED push button and hold, watch Led lights to determine which input is activating, correct as necessary.</p>

TROUBLESHOOTING GUIDE

<i>SYMPTOM</i>	<i>POSSIBLE CAUSE</i>	<i>REMEDY</i>
<p>4. Gate will not open with remote control transmitter.</p> <p>Press open/close push button to verify control board is good.</p>	<p>a. Use on board open/close command button, if gate operates.</p> <p>b. Improper code settings or wiring.</p> <p>b. Weak transmitter battery.</p> <p>c. Poor antenna connection.</p>	<p>Check receiver wiring and receiver</p> <p>Check the code switches in the transmitter & receiver. Verify that they are identical.</p> <p>Replace battery. LED light should illuminate on remote.</p> <p>Check all connections and/or raise the antenna to avoid metal objects.</p>
<p>5. Gate activates open or close for no reason.</p>	<p>a. A shorted signal is coming into the control board from an external control device such as a remote transmitter, pushbutton, keypad, etc.</p> <p>b. Receiving signal from another transmitter</p>	<p>Check all transmitters and pushbuttons for a stuck button.</p> <p>Depress LED push button and hold, watch Led lights to determine which input is activating, correct as necessary.</p> <p>Try changing transmitter and receiver dipswitch settings.</p>
<p>6. Automatic close timer will not close the gate.</p>	<p>a. DS 1 switch setting</p> <p>c. An opening device such as a button, keypad, phone unit, or exit loop detector is shorted.</p> <p>d. A safety device such as a safety loop detector or safety edge is shorted.</p> <p>e. DS 1 switch setting</p> <p>f. Primary or secondary entrapment circuit activated</p> <p>g. Defective control board.</p>	<p>Check switch 1 to verify it is on.</p> <p>Depress LED push button and hold, watch Led lights to determine which input is activating, correct as necessary.</p> <p>Depress LED push button and hold, watch Led lights to determine which input is activating, correct as necessary.</p> <p>Ensure that switch 2 and 9 are set correctly</p> <p>Activate gate using a manual device (transmitter, exit probe etc.)</p> <p>Replace control board.</p>
<p>7. Gate jerks excessively when activated and bounces during cycle.</p>	<p>a. Gate rollers are not correct.</p> <p>b. Chain is incorrect.</p> <p>c. Gate design is weak.</p>	<p>Check rollers and track.</p> <p>Check chain and routing.</p> <p>Replace or reinforce gate.</p>
<p>8. Emergency release knob cannot be pulled.</p>	<p>a. Extreme bind on shaft</p> <p>b. Knob already pulled</p>	<p>Gate needs to be moved by hand while pulling on emergency release knob simultaneously.</p> <p>Try and roll gate manually, if able to roll push knob back in, gate needs to be rolled while pushing in on the knob.</p>

TROUBLESHOOTING GUIDE

<p>9. Gate began to operate increasingly slower and does not operate at all now.</p>	<p>a. Battery has one or more dead cells.</p> <p>b. If AC charged, circuit breaker has tripped or power to charger is interrupted.</p> <p>c. Battery charging system (AC charger or solar panel) is not functioning.</p>	<p>Replace battery.</p> <p>Check circuit breaker. Check for power at charger receptacle.</p> <p>Consult factory for testing instructions. (Test meter required).</p>
<p>10. On a dual gate, only one unit will open and close.</p>	<p>a. Blown fuse</p> <p>b. DS 1 switch settings</p> <p>c. Wiring to the slave gate is damaged.</p>	<p>Replace with 15-amp max.</p> <p>Verify switch 3 and 4 are in the on position (Both 3 & 4 for a dual gate)</p> <p>Check wiring and correct</p>

Accessory Wiring Diagrams

NOTE: Ensure that battery power is disconnected from the control board before wiring accessories to the control board.

Single Button Station to Open/Close

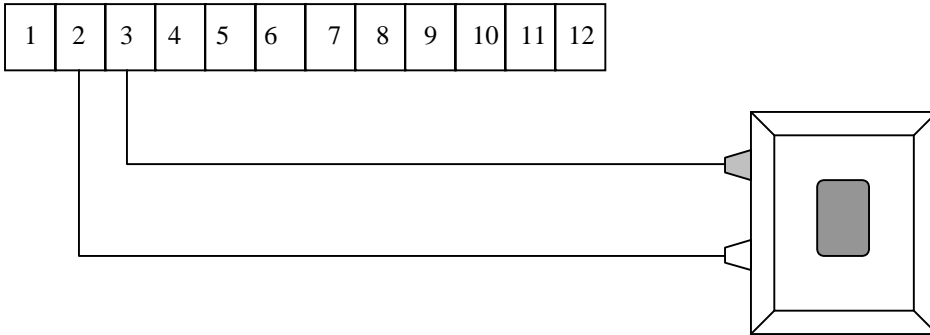

3 Button Station Wiring

Note: Program function switch DS1 #8 must be in the on position for stop button control

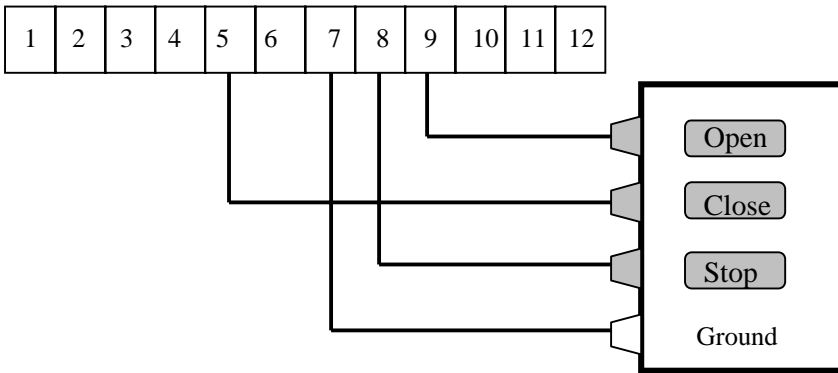

Seven Day Timer to Hold Gate Open – TH800-12

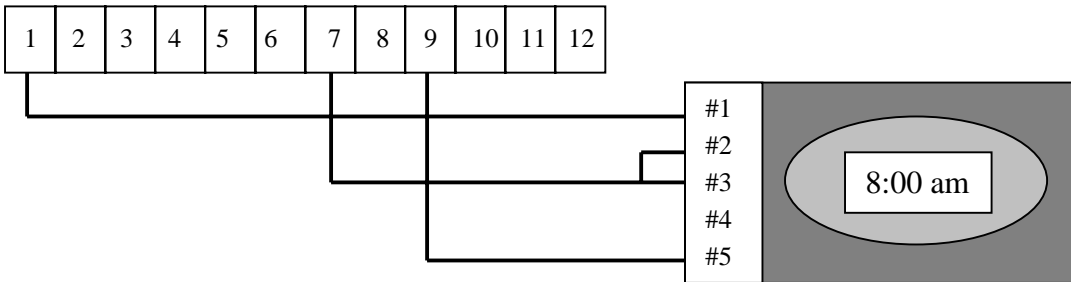

Probe Type Free Exit Magnetic Detector

Wiring shown for MFM sensors Model # MFM-D376 LC

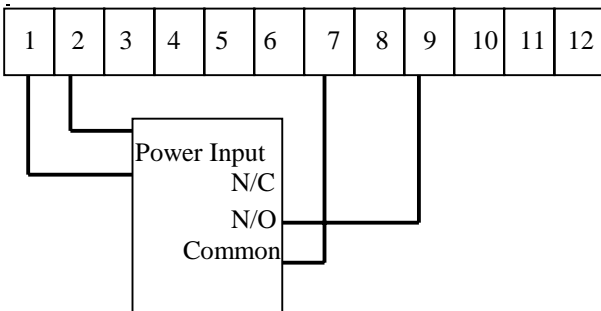

NOTE: This type of detector senses moving vehicles only. It should be utilized as an opening device only. If used as a safety device, the gate will close if the vehicle stops and possible damage will result.

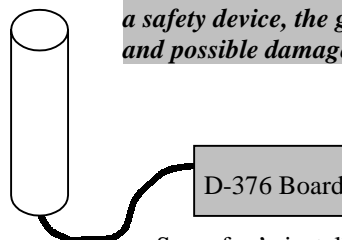

See mfg.'s installation instructions for probe wiring.

Radio Receiver Multi-Code 1099-40/Linear DRG-LV

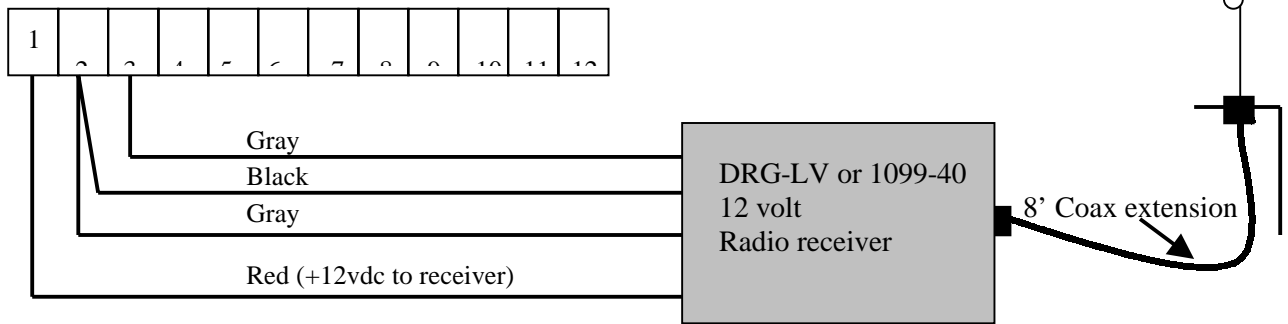

Radio Receiver Allister 9931-LV 3 wire with F Connector

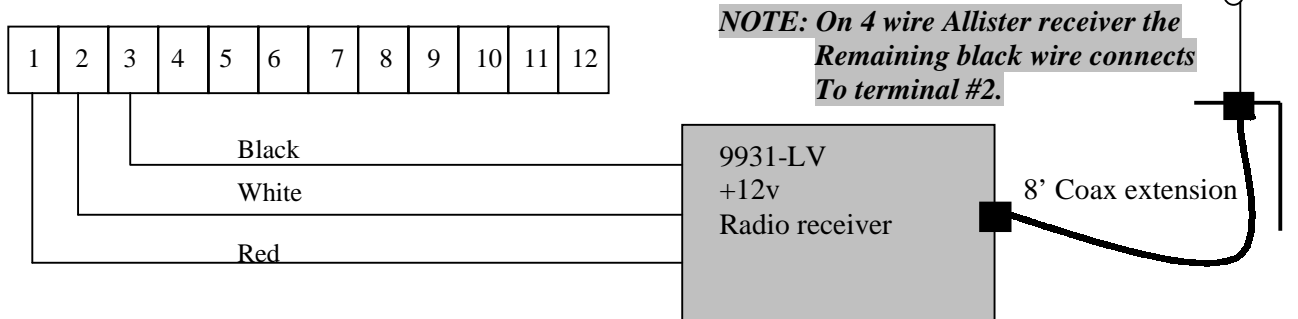

Radio Receiver Liftmaster 412 HM

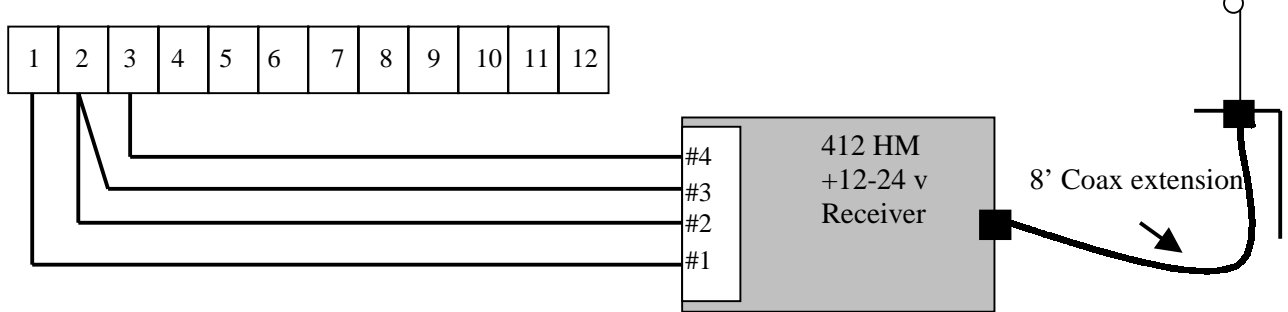

Radio Receiver Linear DRA-F 12 Volt

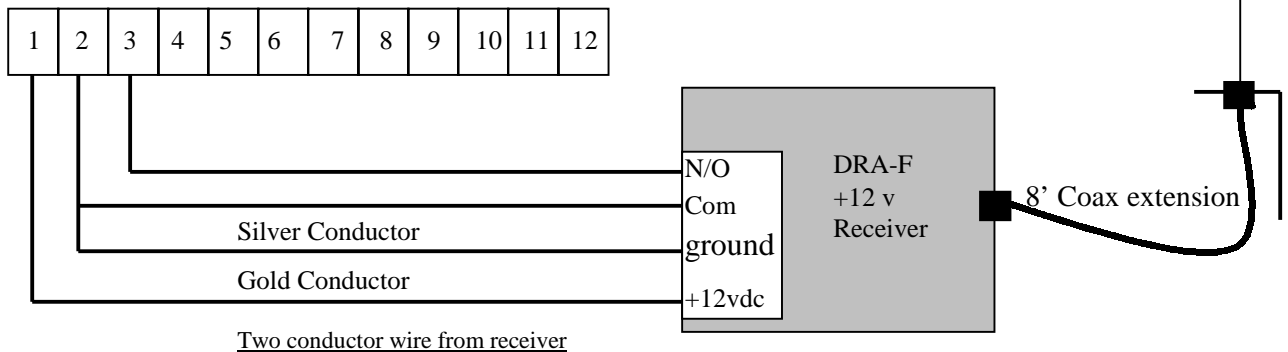

Albano Receiver: (Long Range) Single Channel

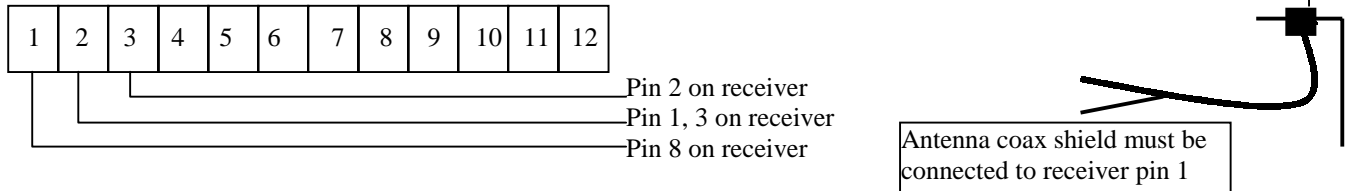

Keypad (12 Volt D.C.)

(Momentary Contact Signal)

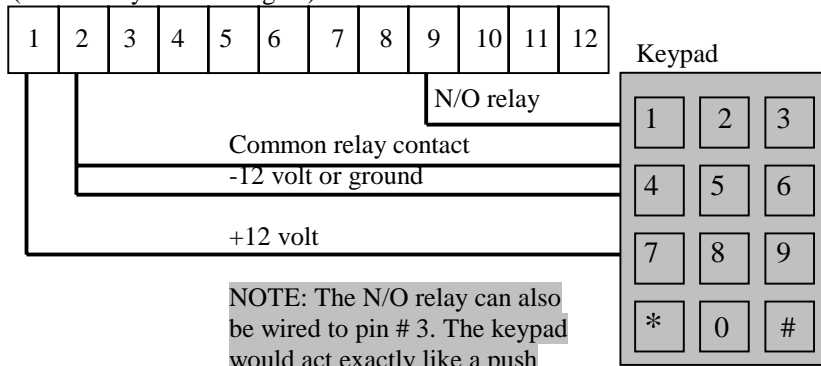

NOTE: The N/O relay can also be wired to pin # 3. The keypad would act exactly like a push button transmitter when code was entered. Maintain open pin # 9.

Card reader

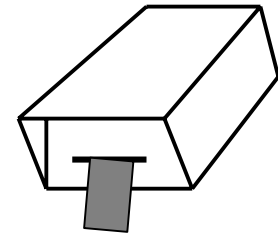

or

Telephone Access Unit Wiring Signal or Hold Open Signal

(Hold open circuit with timer to close override)

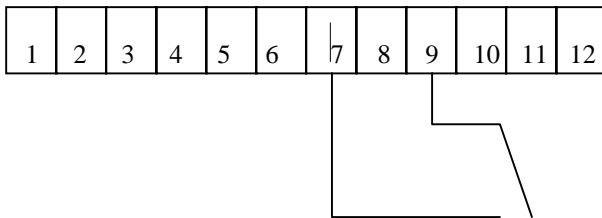

Normally open contacts from any device such as a Free Exit Loop, Maintain Contact Key switch, 7-Day Timer, Telephone Access Unit etc. When the switch contacts close, the gate will open and remain open until the contacts are released. The Close Timer or any close signal will only operate after the switch contacts open.

Photo Eye Wiring for Secondary Entrapment Device

(+12 volt Photo Eye) Wiring shown for Allen Bradley Model # 42GRU-9001



- Stop circuit wiring also available, consult factory

Safety Edge Wiring (Wired Type) Secondary Entrapment Device

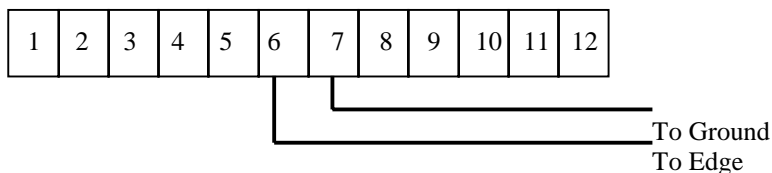

- Stop circuit wiring also available, consult factory

Safety Edge Wiring (Wireless Type) Secondary Entrapment Device

(Safety Edge Transmitter & Radio Receiver)

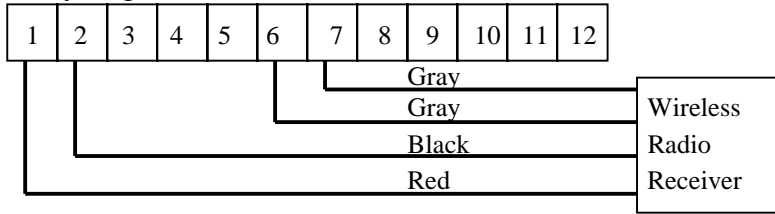

This receiver is for Safety edge only.
Another receiver is required if a Transmitter is used to open the gate

NOTE: Transmitter battery will be drained if Contact edge on gate is depressed constantly.

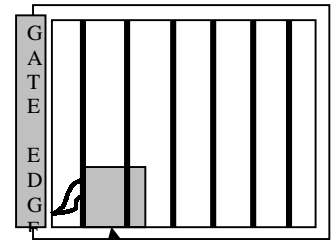

Wireless transmitter connected to gate contact edge.

➤ Stop circuit wiring also available, consult factory

Safety Loop Magnetic Vehicle Detector 12 Volt DC

Wiring shown for Reno Model # BX-LP or BX-LP-SS detector (See Wiring Note Below)

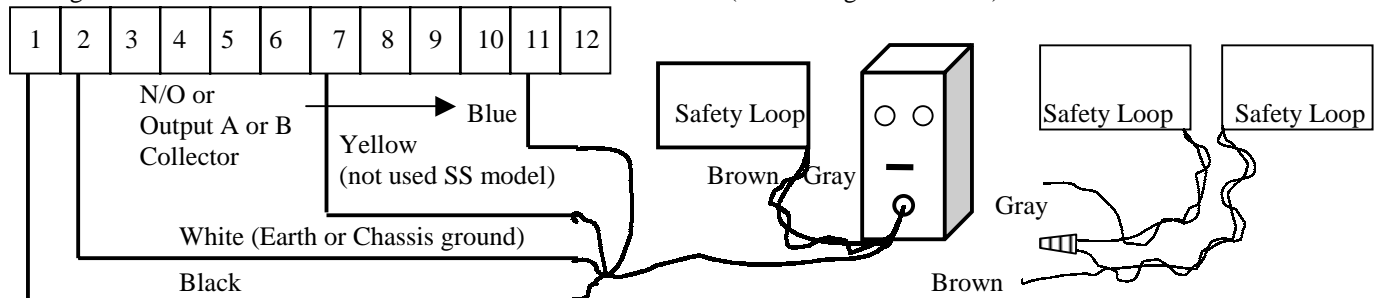

Dual wired loops

Free Exit Loop Magnetic Vehicle Detector 12 Volt DC

Wiring shown for Reno Model # BX-LP or BX-LP-SS detector

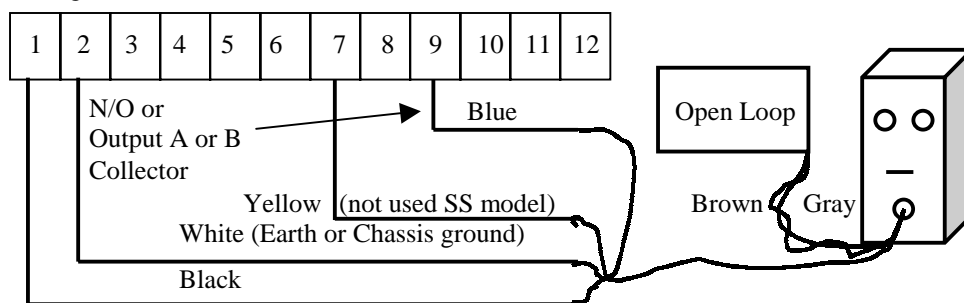

Wiring Note: When using the SS model detector connect detector pins 2 (“power –”) 5 and 9 (“Output A, B Emitter”) Together.

Connect the detector pin corresponding to “output A or B Collector” to the desired pin on the control board.

Safety Loop Magnetic Vehicle Detector 12 Volt DC

Wiring shown for Diablo Model # DSP-5LP detector

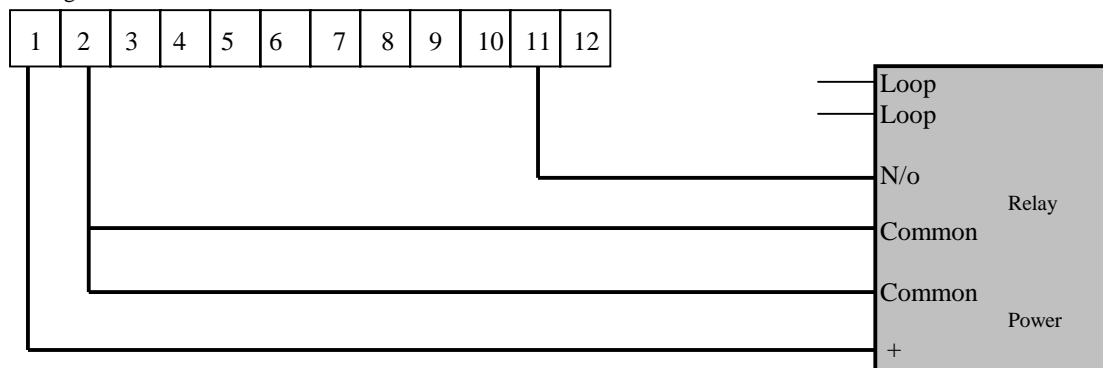

Siren Secondary Entrapment / Indicating Light For Gate Position

Light illuminates anytime gate is not closed (4 second delay)

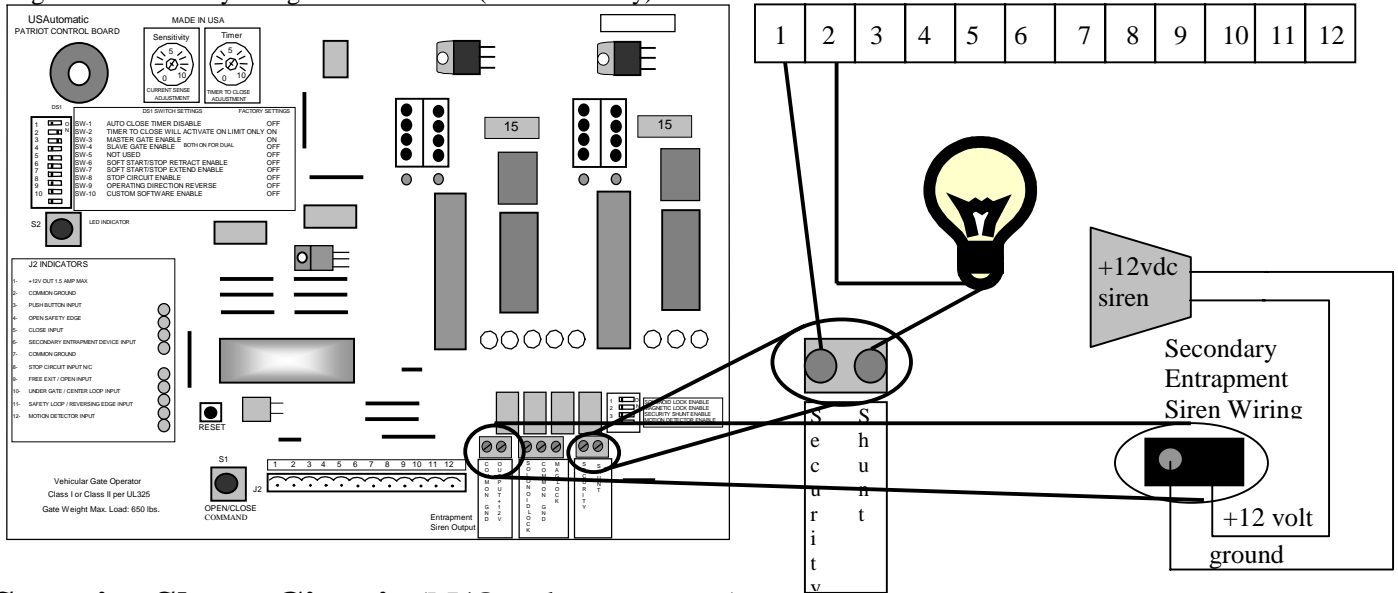

Security Shunt Circuit (N/O relay contact)

This option allows the gate to be activated by a control device without activating the home alarm. The home alarm will activate if gate is forced opened. Security shunt relay will release 4 seconds after close limit. Wire in parallel with gate switch, which is wired into home alarm system.

Program function switch DS2 switch #3 must be "ON" for circuit to operate.

Leading edge of gate and fence post shown using closed type proximity switch.

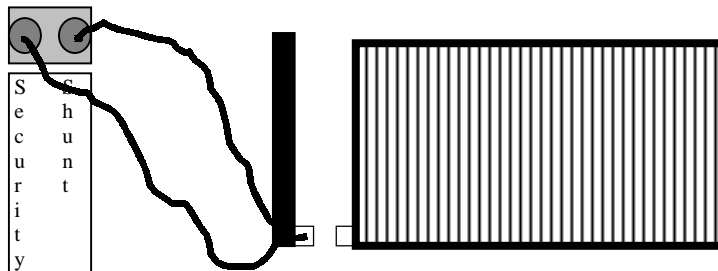

Magnetic Lock Wiring / Stone Lock or any 12 volt DC Solenoid Lock/Siren

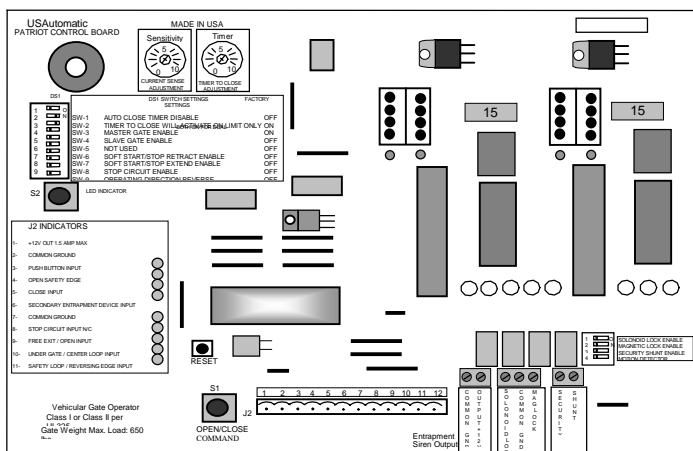

Mag lock and Solenoid lock outputs are labeled On the circuit board. Take care when running wires to avoid pinch areas.

NOTE: The corresponding DS2 switch must be turned on for the desired output to function. Both outputs can be used as long as the current draw does not exceed 1.5 amps.

The Mag lock outputs +12vdc when the gate is on the closed limit. When the control board receives an open input the mag lock output goes to 0vdc .5 seconds before the gate begins to move.

The Solenoid / Siren output is +12vdc 1 second before the gate begins to open or close from a limit. The +12vdc output will remain until a limit is reached plus a 4 second delay. The control board will output the +12vdc 1 second before the gate begins to move and will output +12vdc for 4 seconds after the gate limit is reached. This also allows a siren or light to be operated prior to movement.

The output is regulated to 1.5 amps by a autoreset able fuse.

Loops

Safety and Exit Loop Position Diagram

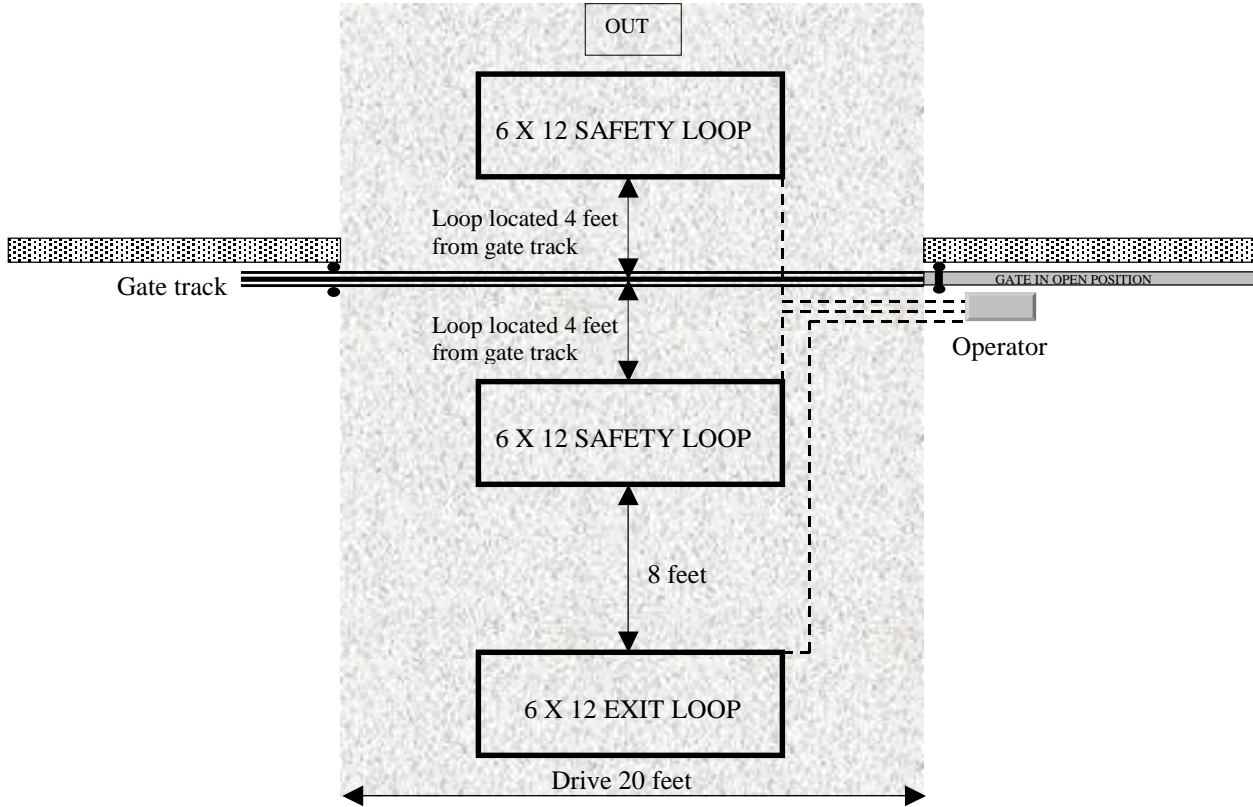

Proper wiring of two loops performing the same function

Example: Inside and Outside Safety Loops

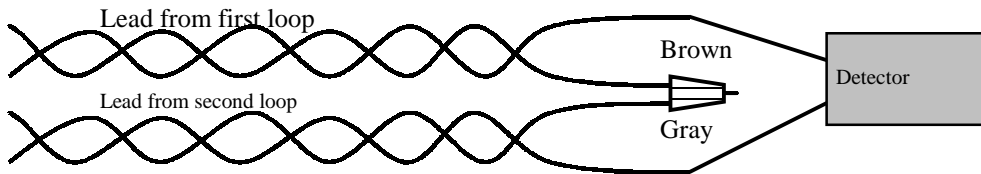

Typical Loop Saw cut - top view

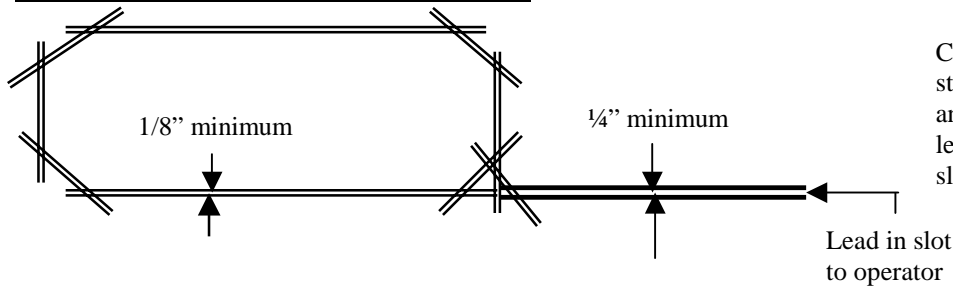

Corners should be cross-cut as shown for stress relief. 45 degrees is maximum turn angle allowed. Sawcut width must be at least 1/8\" for recommended wire. Lead in slot must be at least 1/4\" for twisted leads.

Side view

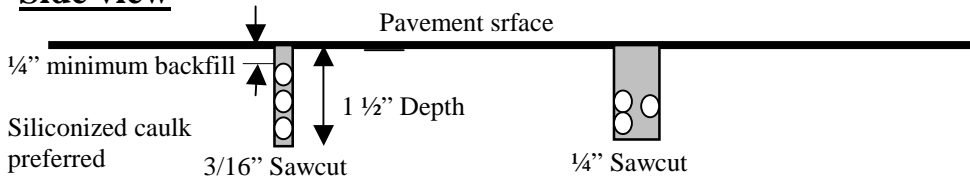

Loops

Loop Size Chart

The loop size is based on the width of the driveway. If the driveway is 14' wide, the loop would be a 6'x6', the minimum. This is determined by subtracting 4' off of each side of the drive, which would leave you 6'.

See chart below for number of turns per loop size, plus lead in. The loop itself should contain between 90 & 125 feet of wire in the loop, plus lead in.

<u>Drive Width Size</u>	<u>Loop Size</u>	<u>Number of Turns</u>		
		<u>2</u>	<u>3</u>	<u>4</u>
14' & Under	6' x 6'			96'
16'	6' x 8'			112'
18'	6' x 10'		96'	
20'	6' x 12'		108'	
22'	6' x 14'		120'	
24'	6' x 16'		132'	
26'	6' x 18'	96'		
28'	6' x 20'	104'		
30'	6' x 22'	112'		
32'	6' x 24'	120'		

The location of the loop is also important. If a loop is located too close to the gate, it will detect the gate itself, giving false operation. If the loop is too far away from the gate a small vehicle might not be detected. Loops should be approximately 5' from the centerline of a gate when closed. See Loop Position on previous 3 pages.

Loops

Other Loop Detector Facts

1. Always clean saw cuts thoroughly with water, air or brush to remove all debris prior to installing wire.
2. Recommended loop wire is TFFN #16 gauge stranded wire. It is available at electric supply distributors.
3. No splices are permitted in the loop or loop leads. One continuous wire should be used.
4. Lead wires should be twisted a minimum of 4 twists per foot to eliminate false sensing. Twists should begin at the edge of the loop and continue to detector.
5. Do not use metal or sharp objects to push the loop wire into the saw cut. The slightest nick or cut in the insulation will cause the loop to ground out and malfunction. To test for shorts, use a megohmmeter or "Megger" between either loop lead and earth ground with both leads disconnected from the detector. The resistance should be greater than 50 megohms.
6. Use siliconized caulk for backfill. Gray for concrete, black for asphalt. 25-Year life rating is preferred.
7. Never set adjacent loops on the same frequency. False activation will occur.
8. Almost all brands of detectors have an external or internal sensitivity adjustment. Usually the factory setting is sufficient if internal adjust type. Be very careful and use extreme caution when decreasing sensitivity.
9. Most false activations are caused by an improperly installed loop or a shorted loop. The loop should be tested and validity determined before adjusting sensitivity. See # 5 above.
10. Most detectors used in the gate business are fail-safe. This means that if the loop fails, the gate will be given a continuous signal. When power is disconnected from a detector, the signal output is also given.
11. ASB, or automatic sensitivity boost is now available on most detectors. This feature should be activated if large truck or trailer traffic is likely.

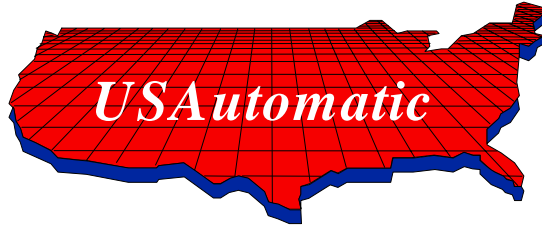

PATRIOT RSL

Limited 5 Year Warranty

The PATRIOT RSL Slide Gate Operator is warranted to be free of defects in materials or workmanship for a period of 5 years from date of purchase on the electronic control board and 12months on all other components. Any part, parts, or complete unit found to be defective within this period will, at the manufacturer's option be repaired or replaced at no charge if returned freight prepaid. New or factory rebuilt replacement parts are warranted for the remaining portion of the original warranty period. The manufacturer will pay for standard ground freight on the return of the repaired or replaced items under this warranty. The manufacturer will not be responsible for field service or labor charges incurred in the removal or replacement of defective parts. Furthermore, the manufacturer will not be responsible for incidental or consequential damages.

This warranty is in lieu of all other warranties expressed or implied and shall be considered void if damage was due to improper use or installation, connection to an improper power source, or if caused by fire, flood, lightning and other acts of nature, or by vehicles or vandalism.

This warranty gives you specific legal rights, and you may have other rights which vary from state to state. Some states do not allow limitations or exclusions of implied warranties so these may not apply to you.

Keep this portion for your records

Model: _____

Serial Number*: _____

Date of Purchase: _____

Purchased from: _____

CUT HERE